

# PENTAFLEX®

Systematic sealing!





## OUR MISSION: FORWARD CONSTRUCTING.

It is our mission not only to provide the very latest building technology, but to also be one crucial step ahead of the game at all times. That is why we are constantly undertaking pioneering work in all product areas. Our employees consistently put their extensive practical experience and creativity to use in the interests of our customers. In constant dialogue with our target groups on a partnership basis, we are already developing the products today that will be needed tomorrow. Our momentum continues to set new benchmarks in structural engineering – yesterday, today and tomorrow, too. This is what we mean by "forward constructing".

# CONTENTS

04 ■  
PENTAFLEX® KB

Seam sheet

10 ■  
PENTAFLEX® FBA

Joint tape connection

12 ■  
PENTAFLEX® ABS

Shuttering element incl. seal

16 ■  
A-CV FB shuttering strip

Combined spacer, positioning gauge and joint shuttering

18 ■  
PENTAFLEX® OBS

Crack control element for in-situ concrete walls

22 ■  
PENTAFLEX® FTS

Crack control element for element walls

26 ■  
PENTAFLEX® STK

Sound-insulating cage

30 ■  
PENTAFLEX® pipe lead-throughs

Leak-proof penetration

36 ■  
PENTAFLEX® sump well

Prefabricated well

38 ■  
PENTAFLEX® OPTI wall strengthener

Tie point

40 ■  
PENTABOX

Reinforcement attachment

42 ■  
GLOSSARY

48 ■  
Service & contact

We are at your service.  
Wherever you are, you can count on us.





# PENTAFLEX®

## PENTAFLEX KB®

### SEAM SHEET



#### THE PRODUCT

PENTAFLEX KB® elements are fully coated on both sides with a special coating. The connection of the special coating with the fresh concrete reliably prevents water infiltrating the joint system. An anchoring depth of 30 mm is enough to withstand water pressure of up to 5.0\* bar. The high elasticity of the coating ensures reliable sealing when the concrete structural components shrink. The individual elements are 2.00 m long and 167 mm or 80 mm high. They are provided with a divided protective film on both sides that is only removed immediately before concreting.

#### ADVANTAGES

- Approved for use in Europe with ETA-15/0003
- CE mark
- Tested for watertightness up to 5.0\* bar
- Regular installation monitoring via standardised line
- Resistant to all types of organic effluents
- Simple and reliable connection of the individual elements and points of intersection
- No special tools or adhesive materials required

#### APPLICATION AREA

PENTAFLEX® can be used in all construction joints, both horizontal and vertical, and in the presence of pressurised and non-pressurised water:

- Construction joints in wall/base or wall/ceiling areas for pressurised and non-pressurised water
- Construction joints in wall/wall or floor/floor areas for pressurised and non-pressurised water

The PENTAFLEX® sealing system is suitable for use in structures of stress class 1 and usage class A in accordance with the watertight structure guidelines.

\* Tested up to 5.0 bar; 2.0 bar permitted in accordance with the ETA [European Technical Assessment] and the abP [general test certificate issued by the German Institute for Civil Engineering (DIBt)] (safety factor of 2.5).



# TECHNICAL INFORMATION

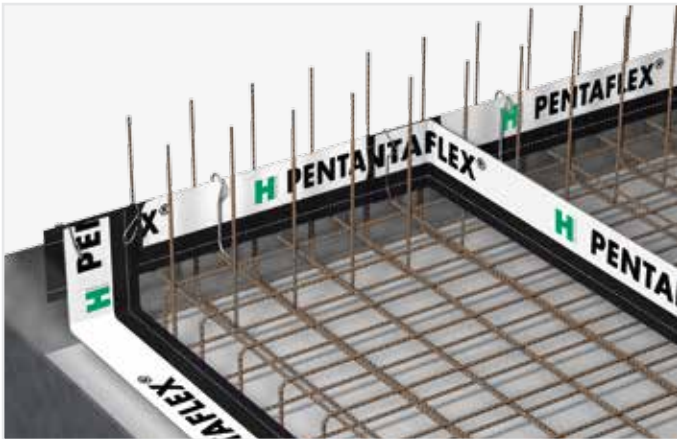

## PENTAFLEX KB® 167

- Individual elements made from galvanised sheet steel that is fully coated
- Dimensions:  
l = 2.00 m  
b = 167 mm  
d = 1.2 mm
- Fixed to the reinforcement with 1 retaining stirrup per metre (see page 14)
- Anchoring depth:  $\geq 30$  mm
- Tested up to 5.0\* bar
- Application: Construction joints in wall/base, wall/wall and floor/floor areas



## PENTAFLEX KB® 80

- Individual elements made from galvanised sheet steel that is fully coated
- Dimensions:  
l = 2.00 m  
b = 80 mm  
d = 1.2 mm
- Fixed to the wall reinforcement with 1 retaining stirrup per metre (see page 14)
- Anchoring depth:  $\geq 30$  mm
- Tested up to 5.0\*\* bar
- Application: Construction joints in wall/ceiling area

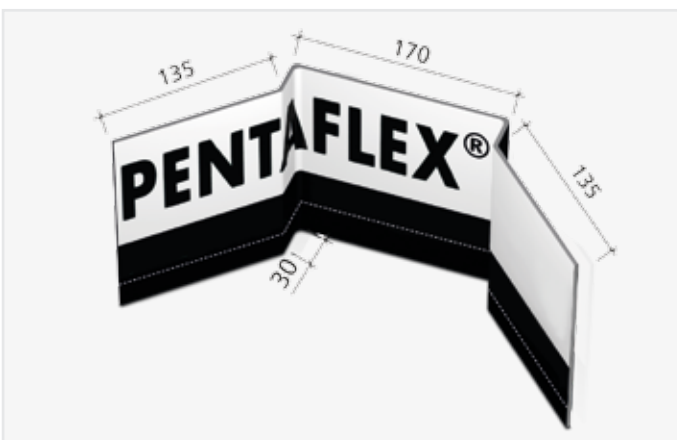

## PENTAFLEX KB® CORNER

- Individual elements made from galvanised sheet steel that is fully coated
- Assembly is carried out by attaching joint clips to the pre-positioned PENTAFLEX KB®
- Sealed against pressurised water up to 5.0\* bar
- Application: Construction joints in the corner area in combination with PENTAFLEX KB® and PENTAFLEX® FTS Corner

\* Tested up to 5.0 bar; 2.0 bar permitted in accordance with the abP [general test certificate issued by the German Institute for Civil Engineering (DIBt)], which corresponds to a safety margin of 2.5 times the test pressure.

\*\* Tested up to 5.0 bar; due to the overall height of  $< 120$  mm, only 1.0 bar of water pressure is permitted in accordance with the abP [general test certificate issued by the German Institute for Civil Engineering (DIBt)].

**NOTE:**

These instructions for installation and use generally apply to all PENTAFLEX KB® applications.

# KB 167 INSTALLATION INSTRUCTIONS

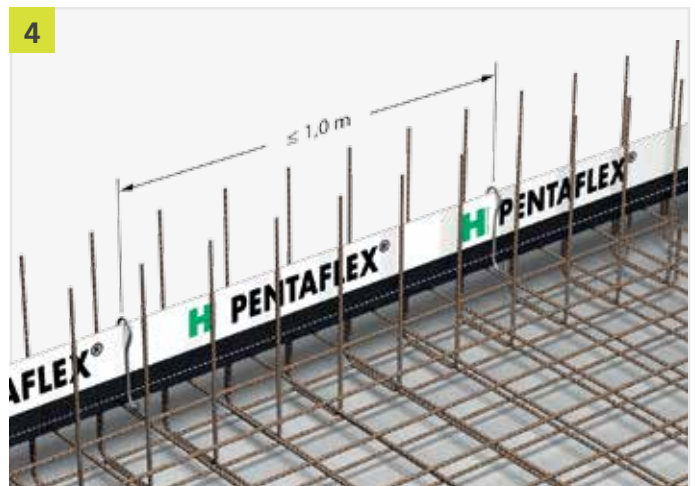
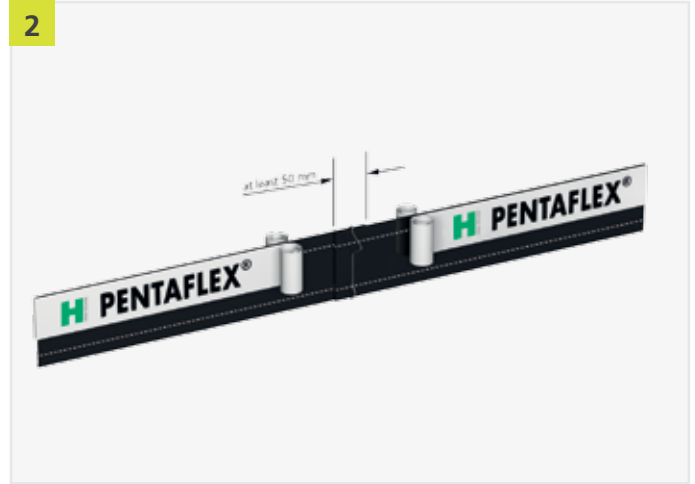

**NOTE:**

Use the PENTAFLEX KB® Corner formed part when building with element walls.

# KB 80 INSTALLATION INSTRUCTIONS

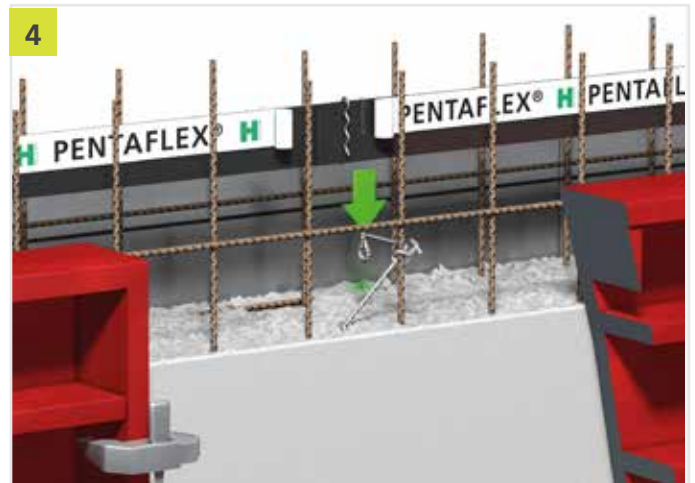
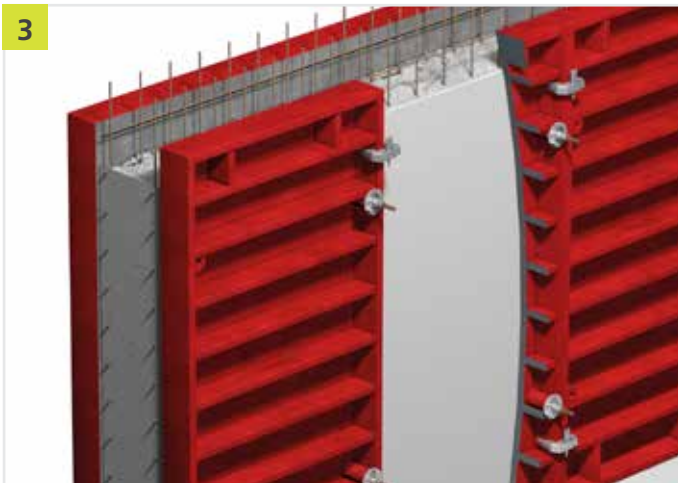
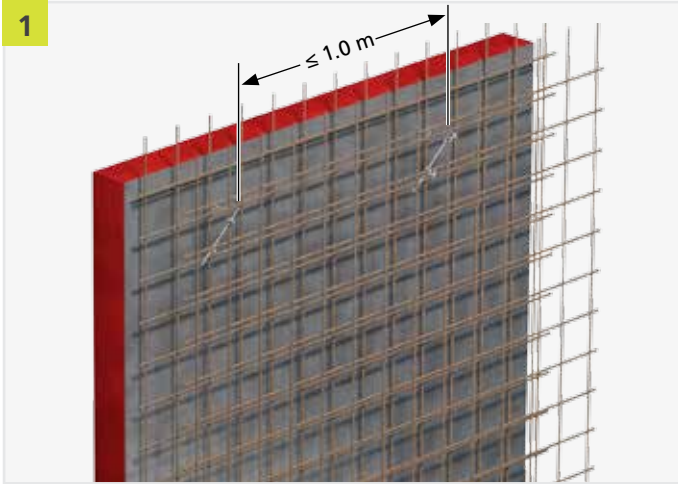

# ACCESSORIES

## PENTAFLEX® RETAINING STIRRUP



## OMEGA STIRRUP

The omega stirrup is a versatile component. It can be used to securely fasten the PENTAFLEX® to the upper layer of reinforcement.

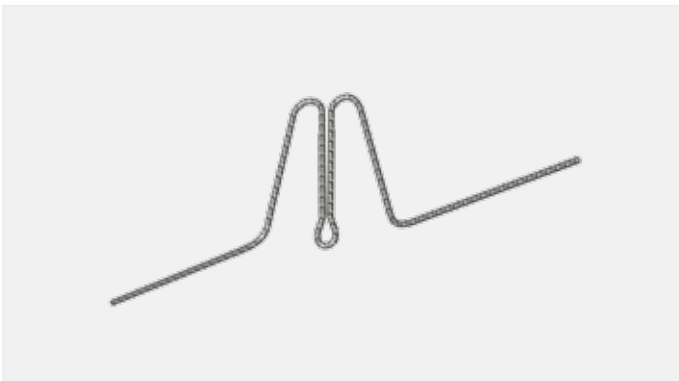

## M-STIRRUP

The PENTAFLEX KB® can be fitted even more easily and quickly in the upper layer of reinforcement using the M-stirrup.



## CLAMP STIRRUP

These spring-steel clamp stirrups interlock independently with the PENTAFLEX® elements. The joint system stands separately on the reinforcement and is only attached at selected points.



## KB 80 STIRRUP

The KB 80 stirrup is designed for fixing the PENTAFLEX KB® 80 elements in the area of wall/ceiling connections. It is tied into the inner mat reinforcement.



## PENTAFLEX® CLIPS

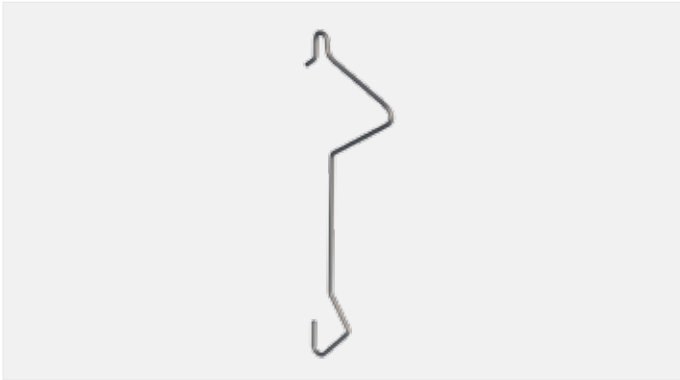

### JOINT CLIPS 167

Every consignment of PENTAFLEX® comes with an ample supply of joint clips. These can be used to quickly and easily secure all straight joints for the PENTAFLEX KB® elements.

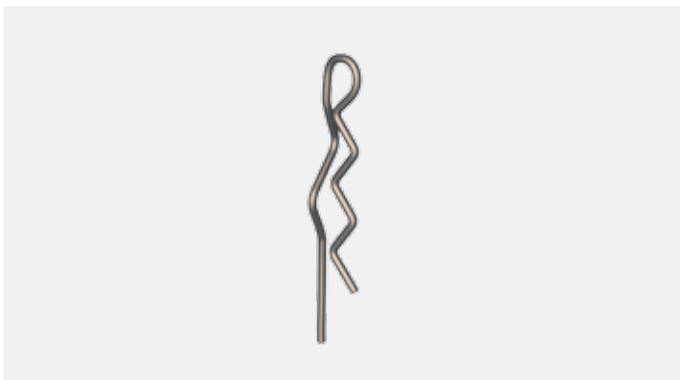

### JOINT CLIPS 80

Every consignment of PENTAFLEX® comes with an ample supply of joint clips. These can be used to quickly and easily secure all straight joints for the PENTAFLEX KB® 80 elements.



### CROSS CLIP

The purpose of the clips is to secure joints mechanically. These clips are used to secure all of the points of intersection.

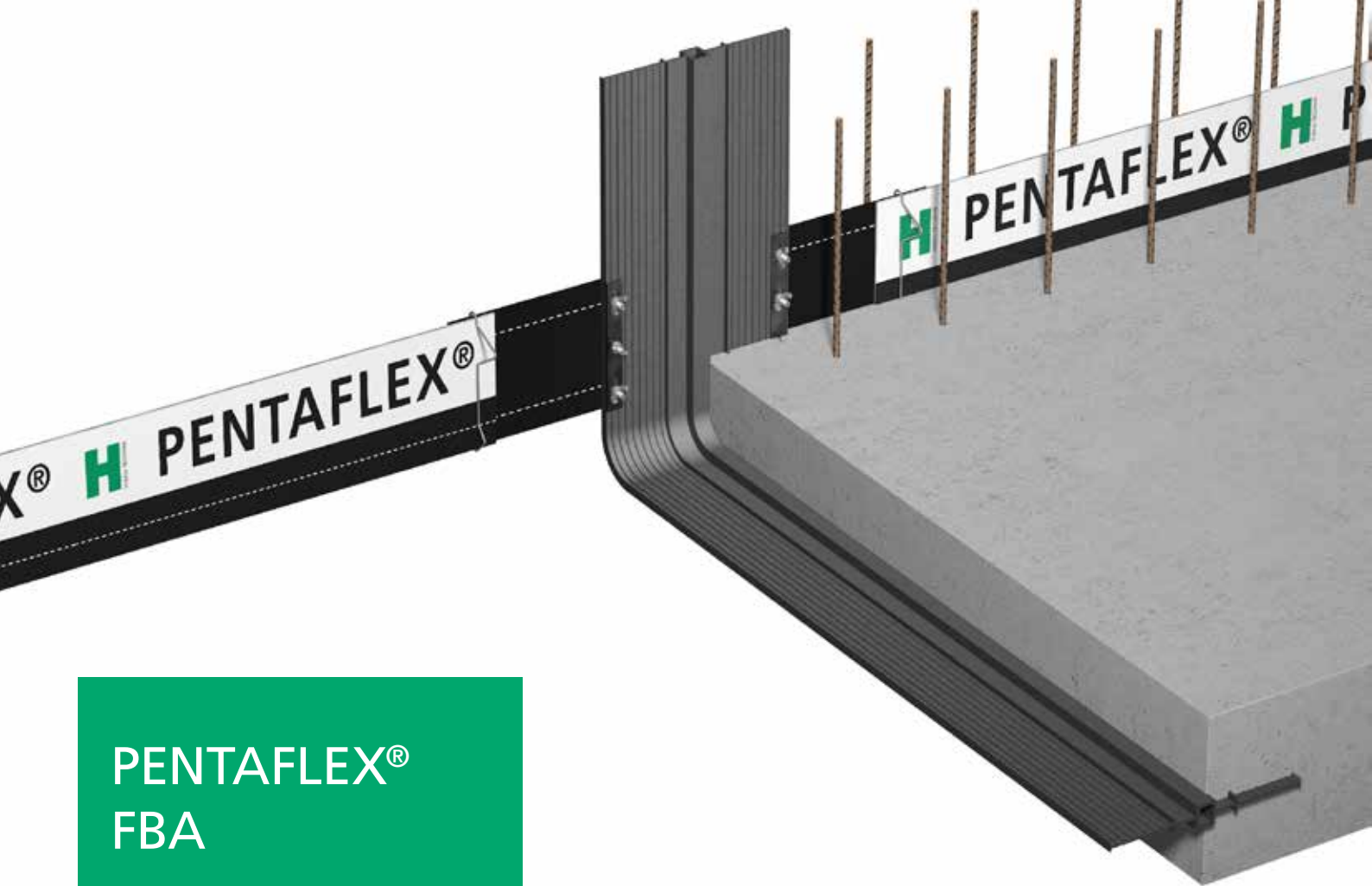

## PENTAFLEX® FBA

### JOINT TAPE CONNECTION

#### THE PRODUCT

The PENTAFLEX® joint tape connection FBA consists of a clamping device with a sealing strip. The FBA makes it possible to connect KUNEX® joint tapes to PENTAFLEX® KB elements. The FBA is connected to the joint tape at the end piece of the PENTAFLEX® element via a screw-type clamping device.

#### ADVANTAGES

- Secure connection of PENTAFLEX® to KUNEX® joint tapes
- Connection tested up to 5.0 bar
- Easy assembly
- No special tools or adhesive materials required

#### APPLICATION AREA

The PENTAFLEX® joint tape connection FBA can be used to integrate KUNEX® construction and expansion joint tapes into the sealing concept while retaining compatibility with the system. Transitions from PENTAFLEX® seam sheets to KUNEX® joint tapes can be established quickly and easily.

# TECHNICAL INFORMATION

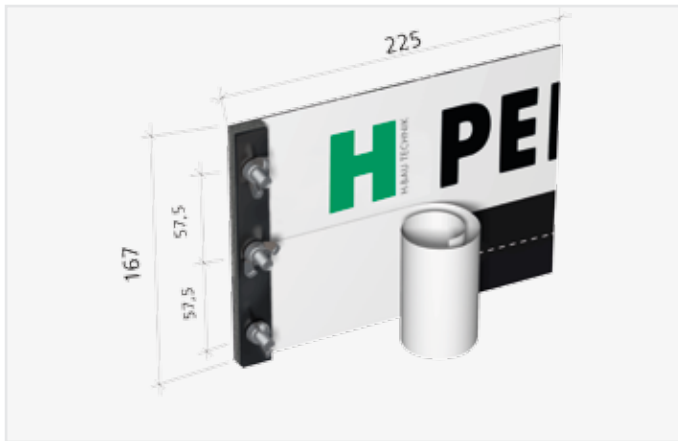

## BASIC INFORMATION

- Individual elements made from galvanised sheet steel that is fully coated
- Dimensions:
  - l = 225 mm
  - b = 167 mm
  - d = 1.2 mm
- Anchoring depth:  $\geq 30$  mm

## INSTALLATION INSTRUCTIONS

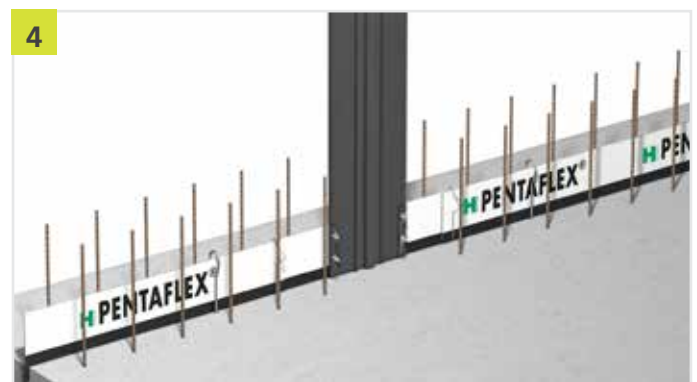
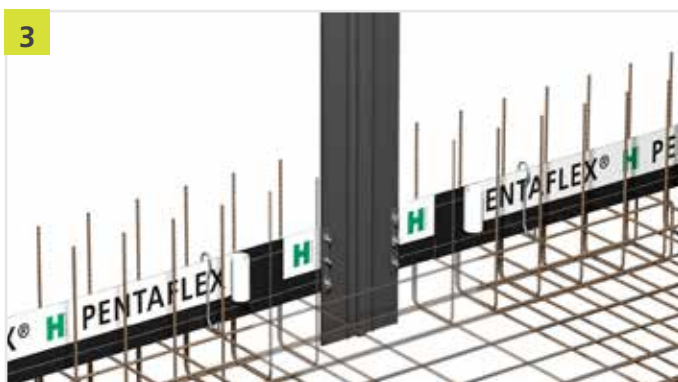
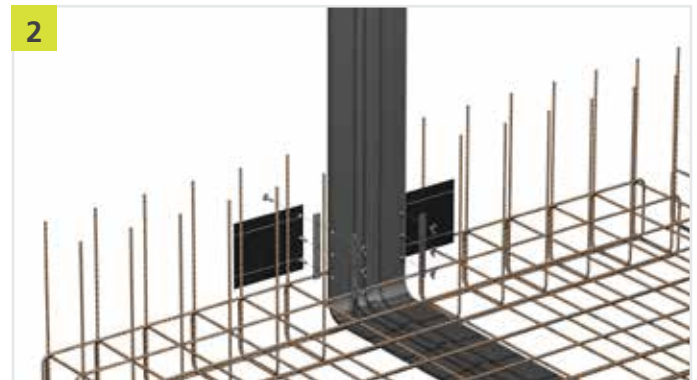
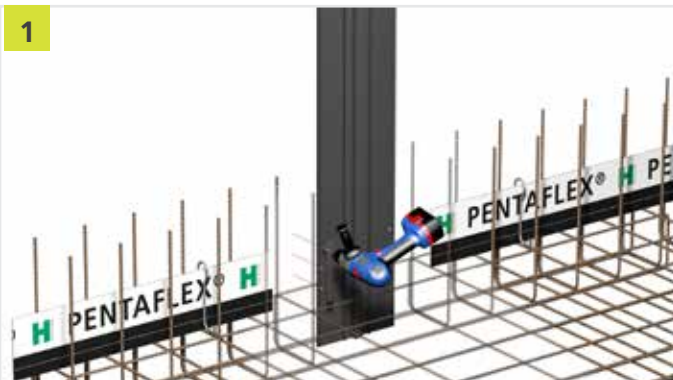

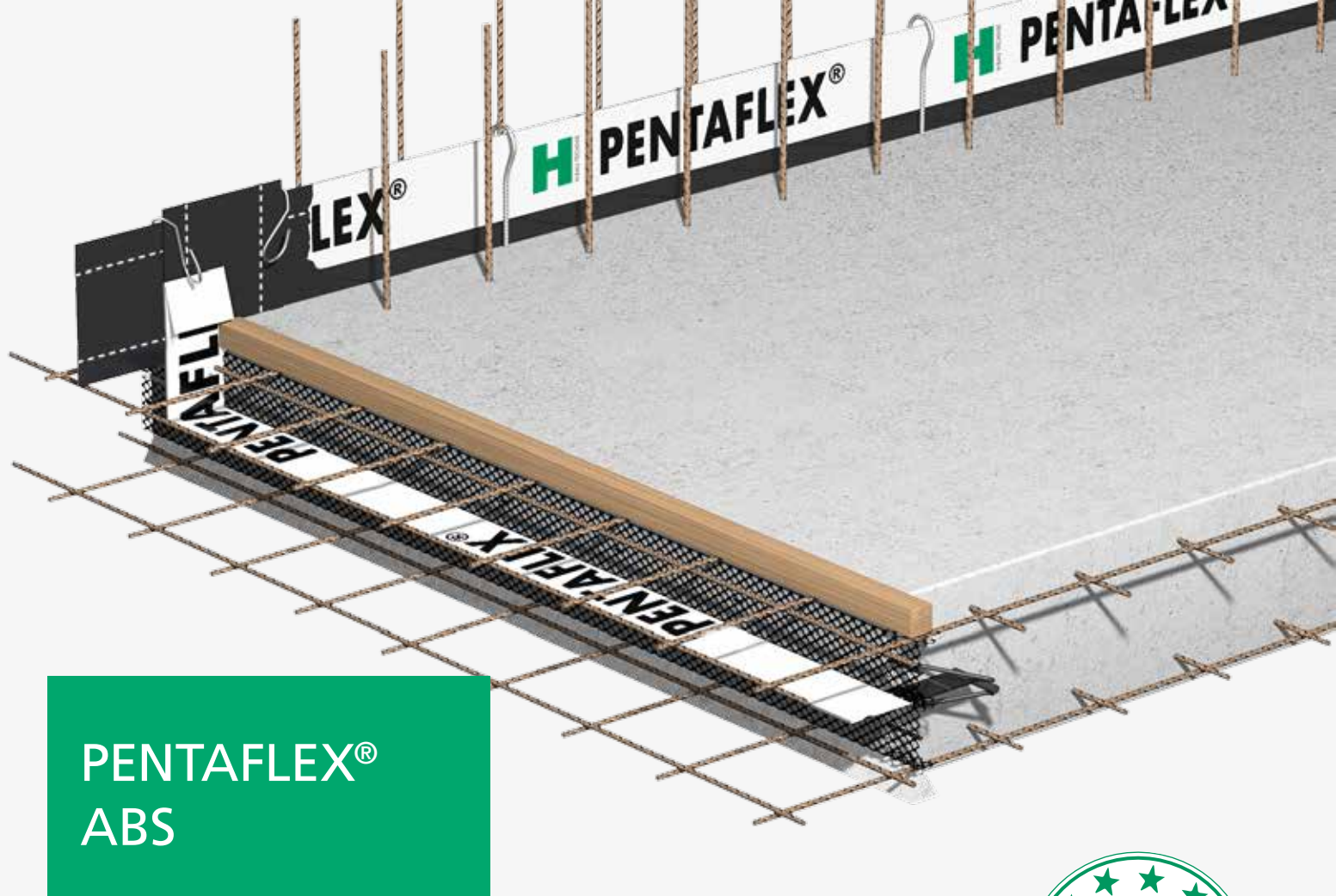

# PENTAFLEX® ABS

## SHUTTERING ELEMENT INCL. SEAL



### THE PRODUCT

The PENTAFLEX® ABS shuttering element is a combination of seam sheet and profiled formwork. The joint is reliably sealed by the tried-and-tested PENTAFLEX KB®. The shuttering is created using dimensionally stable metal mesh elements, which are reinforced using a special stirrup construction. The ABS element can be supplied as a coarse or interlocking joint (ABS-R, ABS-V).

### ADVANTAGES

- Approved for use in Europe with ETA-15/0003
- CE mark
- High shear strength in the bonding joint
- Watertight up to 5.0 bar\*
- Joints do not have to be welded
- For continuous reinforcement
- PENTAFLEX® special coating resistant to organic effluents
- Easy and reliable connection with the PENTAFLEX® KB in the floor-wall joint

### APPLICATION AREA

PENTAFLEX® ABS is used to create construction joints for reinforced concrete slabs exposed to water (floors, walls and ceilings), particularly for applications that require bonding joints with a high shear strength.

\* Tested up to 5.0 bar; 2.0 bar permitted in accordance with the ETA [European Technical Assessment] and the abP [general test certificate issued by the German Institute for Civil Engineering (DIBt)] (safety factor of 2.5).





# TECHNICAL INFORMATION

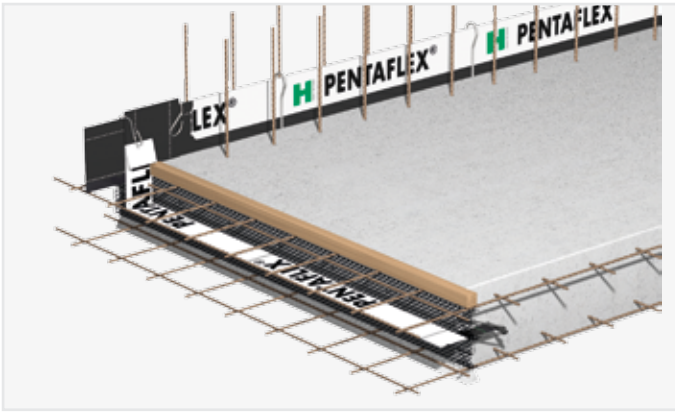

## BASIC INFORMATION

- PENTAFLEX KB® seam sheet
- Standard shuttering element length:  $L = 2.40 \text{ m}$
- Fixed lengths possible
- Installation dimension:  $E \geq 80 \text{ mm}$
- Special forms are possible

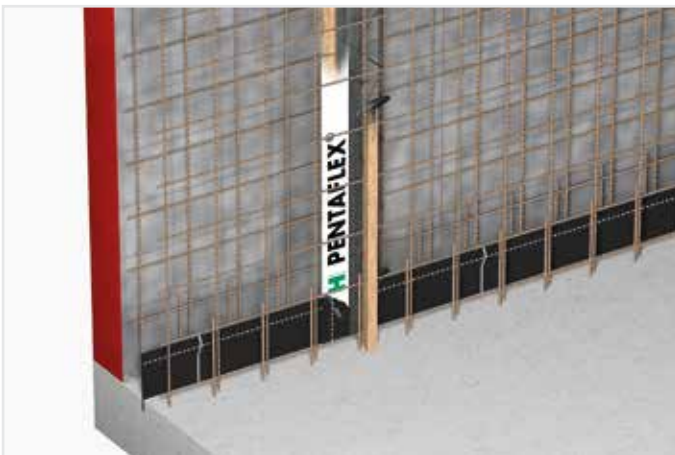

## SYSTEM SECTION

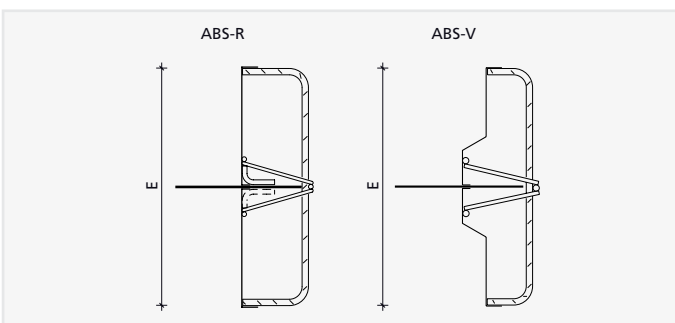
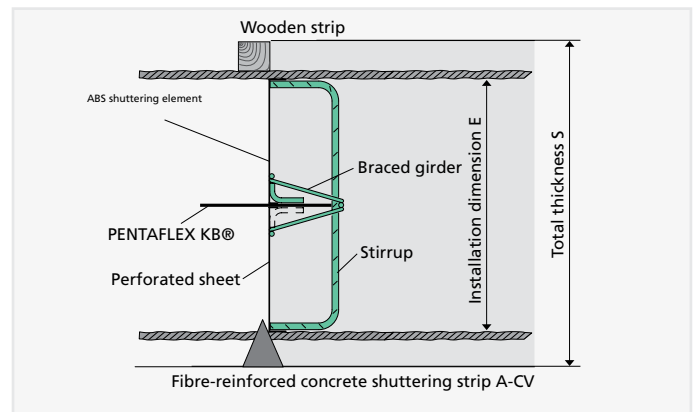

## VERSIONS

ABS-R for coarse joints

- Installation dimension:  $E \geq 80 \text{ mm}$

ABS-V for interlocking joints

- Interlocking joint in accordance with EC 2
- Installation dimension:  $E \geq 140 \text{ mm}$

## NOTE:

In order to prepare an exact quotation we require precise details of intended purpose, joint length, installation height and connection points.

# INSTALLATION INSTRUCTIONS (FLOOR/FLOOR, CEILING/CEILING)

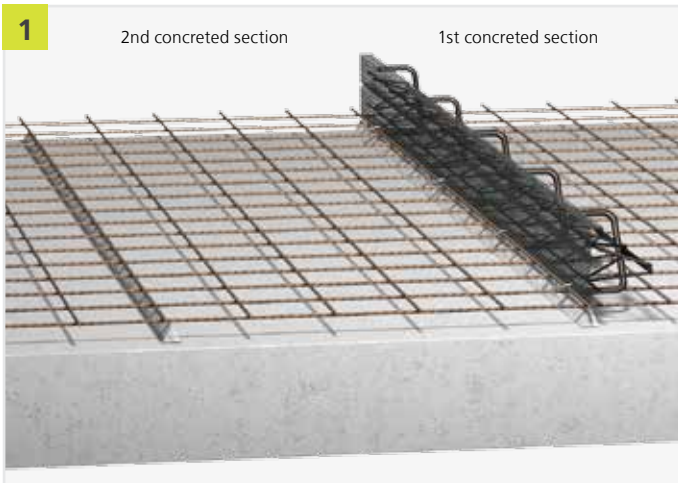

Insert a suitable spacer of size  $c_{nom}$  on the subbase/formwork at the location where the construction joint should be placed (level of the expanded metal sheets).

Install the ABS elements on the lower reinforcement layer. Select the direction of installation so that the braced girder protrudes into the first concreted section. Attach it to the lower reinforcement using tie wire. Alternatively, the element can be welded to the reinforcement.



Lay the upper reinforcement and the shuttering for the upper concrete covering. Attach the ABS element to the upper reinforcement using tie wire. Alternatively, the element can be welded to the reinforcement.

Before concreting the second section, remove the protective film on the top and bottom of the seam sheet.

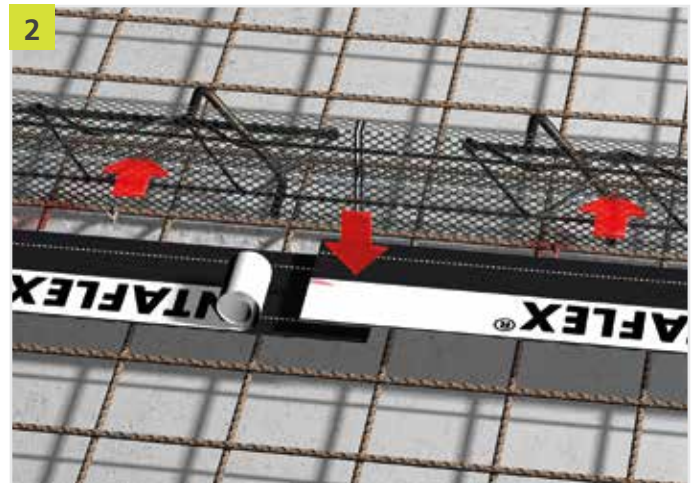

Extend the ABS elements via butt jointing. Peel the film off one side of the PENTAFLEX KB® element (top and bottom) and push it as far as it will go into the shuttering. The seam sheets must overlap by 50 mm, be pressed firmly together and secured with a cross clip. At temperatures below +5 °C, the faying surface must be heated.

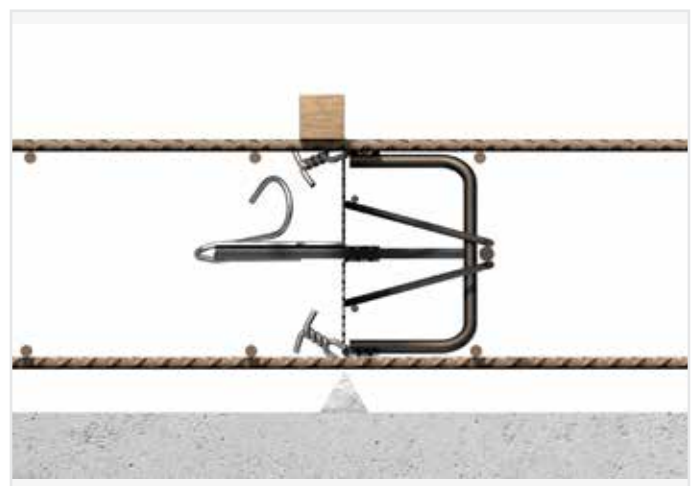

Section clarifying the installation position.

# INSTALLATION INSTRUCTIONS (WALL/WALL)

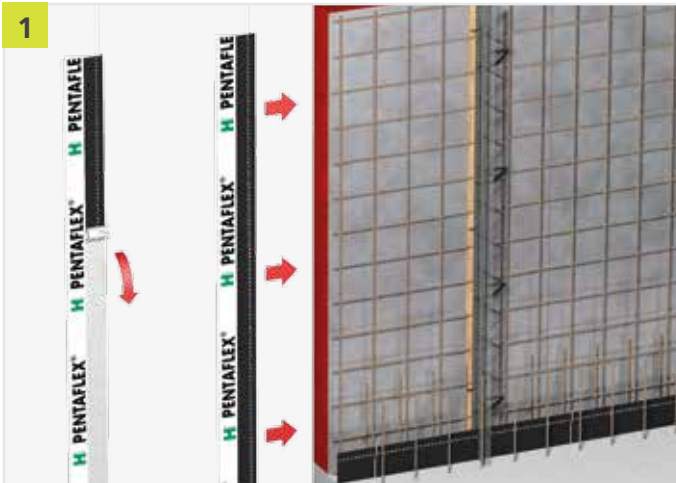

Place the external formwork and attach a trapezoidal strip at the position of the construction joint. Introduce outer reinforcement. Use spacers that are designed for use with water-impervious construction. Position the ABS element over the PENTAFLEX KB® of the floor/wall joint and tie or weld to the reinforcement. Peel off the backing paper on both sides of the area of the first concreted section and insert the sheet into the shuttering as far as it will go.

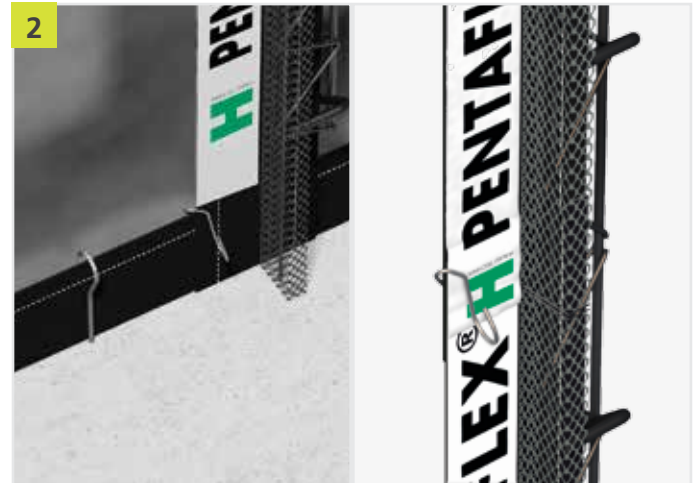

The joints must overlap by 50 mm. At temperatures below +5 °C, the joint must be heated. Secure the connection with cross clips.

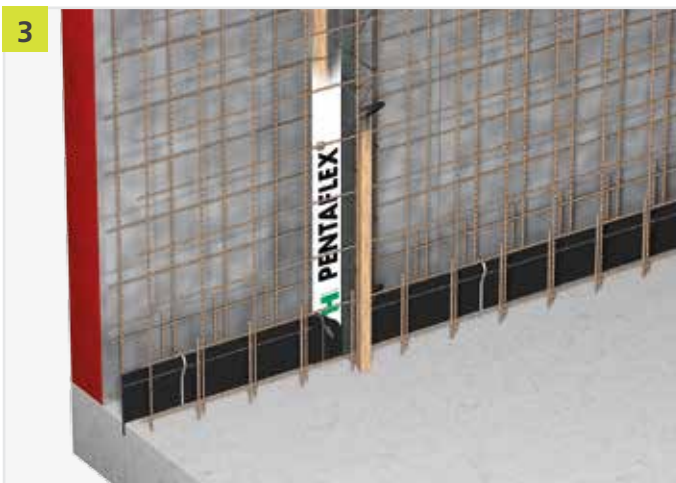

Install the inner reinforcement and secure it to the ABS element (tie wire or welding). Fasten the trapezoidal strip and close the formwork. Use tie points that are compatible with water-impervious construction.



Before erecting the formwork for the second concreted section, remove the remaining protective film from the PENTAFLEX KB®, reinforce the component and close the formwork.



# ACCESSORIES

## FIBRE-REINFORCED CONCRETE SHUTTERING STRIP A-CV

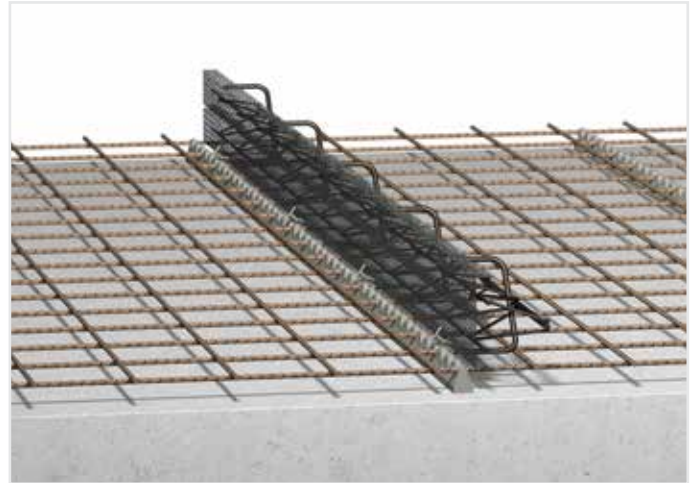

### THE PRODUCT

This spacer is made from fibre-reinforced concrete with a 50 mm reinforcement grid, and is an ideal complement to the PENTAFLEX® ABS, A and AX shuttering elements, with either a rough or interlocking design. The A-CV shuttering strip reliably ensures that concrete leakage and the associated loss of fine particles are kept to a minimum.

It can accommodate rod diameters of 6 to 14 mm and is available for concrete coverings from 20 to 60 mm. This makes it ideal as an installation aid for steel-bar reinforcements.

### DIMENSIONS

Type	Concrete cover [mm]	Height/Length [mm]
A-CV 20	20	40/1000
A-CV 25	25	45/1000
A-CV 30	30	50/1000
A-CV 35	35	55/1000
A-CV 40	40	60/1000
A-CV 45	45	65/1000
A-CV 50	50	70/1000
A-CV 60	60	80/1000

### ADVANTAGES

- No seepage from the construction joint
- Saves time
- Improved quality
- Universally usage
- Facilitates self-inspection and acceptance of the reinforcement

### APPLICATION AREA

The A-CV shuttering strip also serves as a gauge when using steel bars, eliminating the need to measure and mark a grid on the sub-base. The A-CV shuttering strip is used when laying longitudinal and transverse reinforcements for a range of concrete coverings.



# ACCESSORIES

## FIBRE-REINFORCED CONCRETE SHUTTERING STRIP AS-CV

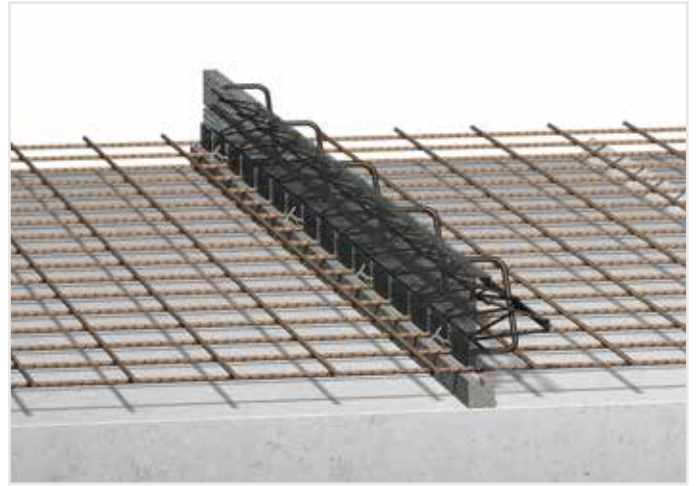
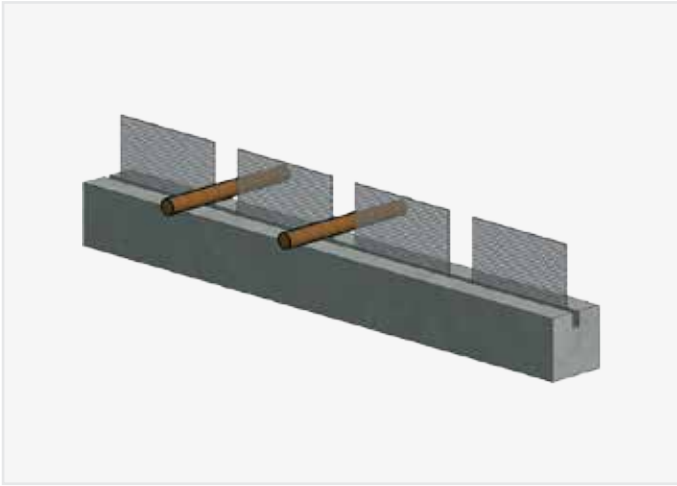

### THE PRODUCT

Spacers ensure that the reinforcement is covered with concrete and shuttering elements provide a simple and economical way of making construction joints impervious to water – but the areas between the reinforcement rods crossing the joint constitute a major design flaw. These sections of the construction joint formwork are not normally closed. This allows concrete to escape, something which is not conducive to achieving a geometrically clean joint. A huge number of fine particles are washed out, which not only affects the water imperviousness of the concrete right in the barrier layer, but also creates quality flaws for the next concreted section.

### DIMENSIONS

AS-CV	Concrete covering [mm]	Reinforcement axis spacing [mm]
30/100	30	100
30/150	30	150
30/200	30	200
35/100	35	100
35/150	35	150
35/200	35	200
40/100	40	100
40/150	40	150
40/200	40	200
50/100	50	100
50/150	50	150
50/200	50	200

### ADVANTAGES

- Flawless geometric formation of the construction joint
- Ensures homogeneous water-impervious concrete quality
- Unimpeded section formation in the second concreted section over the entire slab thickness
- Perfect reinforcement grid without calibration

The reinforcement diameter used must be indicated



# PENTAFLEX® OBS

## CRACK CONTROL ELEMENT FOR IN-SITU CONCRETE WALLS



### THE PRODUCT

PENTAFLEX® OBS crack control elements for in-situ concrete walls comprise a joint element with the tried-and-tested PENTAFLEX® special coating and galvanised sheet steel wings that separate the concrete cross-section.

The elements are manufactured as standard in 2.50 m, 2.75 m and 3.00 m lengths. The slotted wings are available for all wall thicknesses. Standard elements for walls with thicknesses of 240 mm, 250 mm and 300 mm are stock items. The elements are supplied ready for installation.

### ADVANTAGES

- Approved for use in Europe with ETA-15/0003
- CE mark
- Freely selectable concreting cycle
- Elements are quick and easy to assemble
- Reliable formation of the shrinkage crack thanks to complete separation of the concrete cross-section
- Watertight up to 5.0 bar\*
- PENTAFLEX® special coating resistant to organic effluents
- Easy and reliable connection with PENTAFLEX KB®

### APPLICATION AREA

PENTAFLEX® OBS crack control elements are used to create cracks at predetermined points in in-situ concrete walls. When a crack forms, it is secured against both pressurised and non-pressurised water by the sealing element. Shrinkage cracks no longer occur randomly – instead they form at planned breaking points where they are sealed immediately.

\* Tested up to 5.0 bar; 2.0 bar permitted in accordance with the ETA [European Technical Assessment] and the abP [general test certificate issued by the German Institute for Civil Engineering (DIBt)] (safety factor of 2.5).

# TECHNICAL INFORMATION



OBS crack control element

## BASIC INFORMATION

- PENTAFLEX KB® seam sheet
- Element length:  $l = 2.50 \text{ m}; 2.75 \text{ m}; 3.00 \text{ m}$   
Fixed lengths available on request
- Installation dimension:  $E = 100 \text{ mm to } 300 \text{ mm}$
- Standard installation dimension:  $E = 140 \text{ mm and } 180 \text{ mm}$   
for wall thicknesses of  $240\text{--}250 \text{ mm}$  and  $300 \text{ mm}$
- Seam sheet overlap at top and bottom for connection to the PENTAFLEX KB®

Larger installation dimensions on request. Should you require any further assistance, our Application Technology team will be happy to help.  
Phone: +49 (0) 7742 9215-300  
Fax: +49 (0) 7742 9215-319  
E-mail: [technik@h-bau.de](mailto:technik@h-bau.de)



Detail of OBS base point

## SYSTEM SECTION

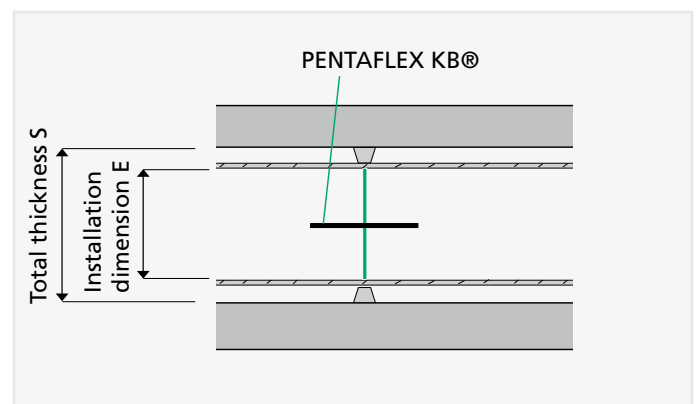

# INSTALLATION INSTRUCTIONS

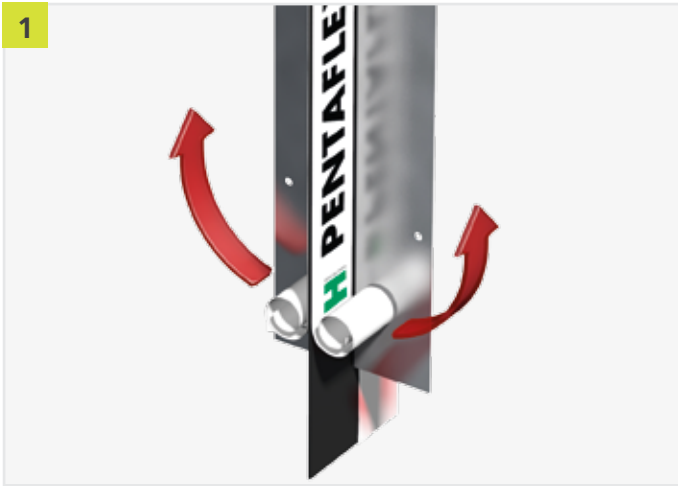

Remove all films from the PENTAFLEX® OBS elements.

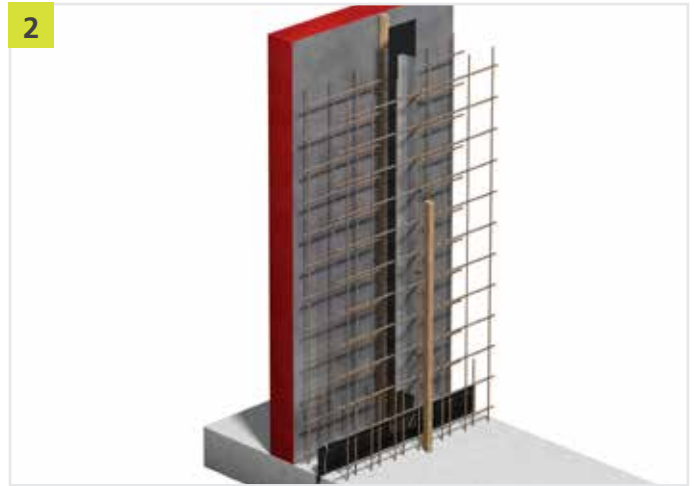

Install a suitable shuttering of size  $c_{nom}$  into the formwork at the exact point where the predetermined crack ought to form (level of the assembly sheet steel).



Install the OBS element in the wall formwork between the outer and inner reinforcement layers. Tie wire is used to attach it. Thread the wire through the holes provided in the assembly sheets and fix tie to the reinforcement. The position of the OBS element must be fixed so that the assembly sheet steel is immovable at the level of the planned pre-break point; this means that the sealing plane will be exactly parallel with the surface of the formwork on the axis of the floor/wall joint seal.

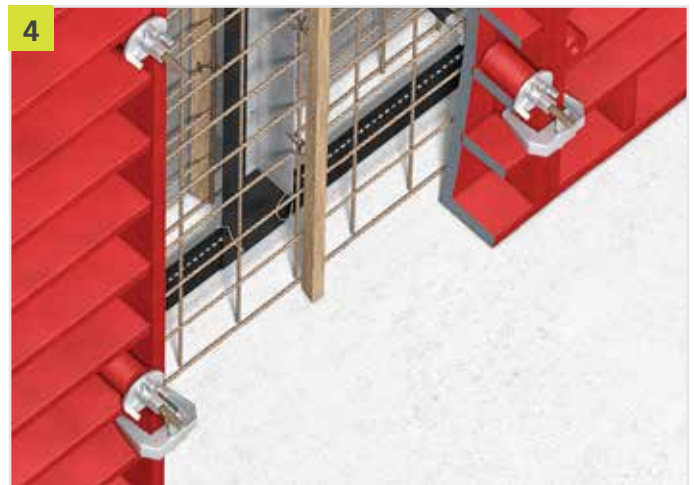

The OBS element is then attached to the PENTAFLEX KB® by creating an overlap of at least 50 mm and pressing the coated sheets firmly together. At temperatures below +5 °C, the faying surfaces must be heated.



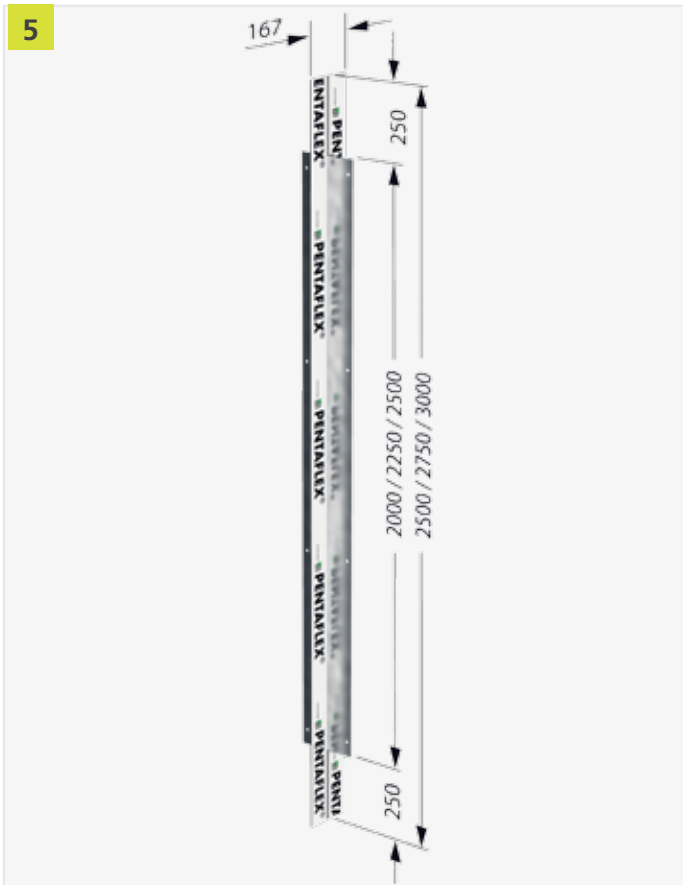

Each joint must be secured with two cross clips. Before the wall formwork is closed, suitable shuttering, such as a scaled trapezoidal strip, must be attached in the axis of the OBS element assembly sheets.

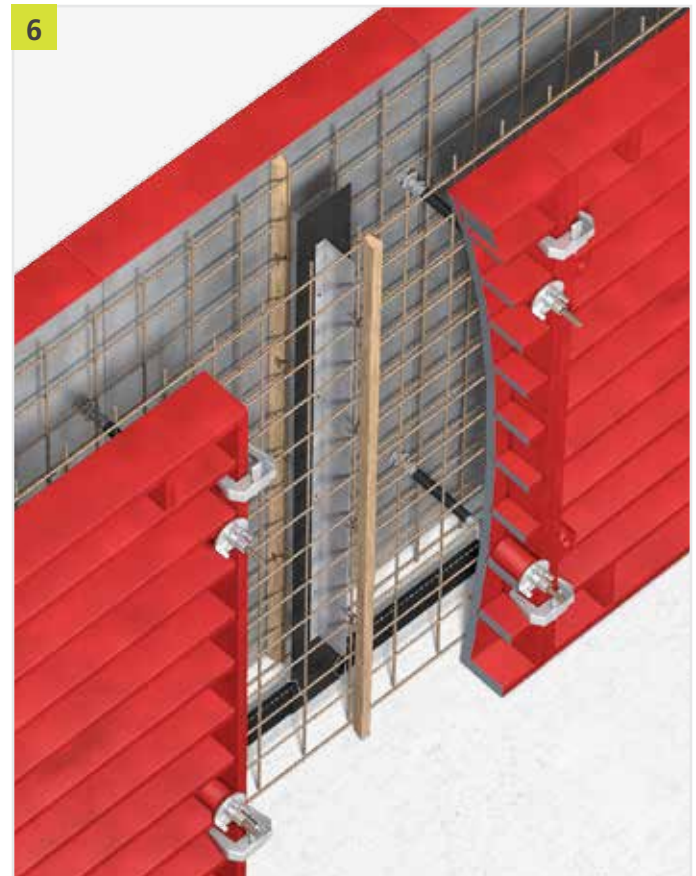

Care is required when concreting to ensure that the OBS element is not exposed to concrete pressure on one side. Keep the pouring height equal on both sides. Joints and connections must be made and secured as shown in point 3.



# PENTAFLEX® FTS

## CRACK CONTROL ELEMENT FOR ELEMENT WALLS



### THE PRODUCT

PENTAFLEX® FTS crack control elements for walls comprise a seam sheet with the tried-and-tested PENTAFLEX® special coating as well as a galvanised sheet steel wing. This weakens the concrete section and at the same time allows the flashing to be attached.

The elements are manufactured as standard in 2.50 m, 2.75 m and 3.00 m lengths. The PENTAFLEX® FTS joint element is available for every wall thickness. Standard elements for 240–250 or 300 mm thick walls are stock items.

The elements are supplied ready for installation.

### ADVANTAGES

- Approved for use in Europe with ETA-15/0003
- CE mark
- Elements are quick and easy to install on the prefabricated formwork
- Reduced waiting times
- Reliable generation of the shrinkage crack
- Watertight up to 5.0 bar\*
- PENTAFLEX® special coating resistant to organic effluents
- Easy and reliable connection with PENTAFLEX KB®

### APPLICATION AREA

PENTAFLEX® FTS crack control elements are used to create a crack at a predetermined point in element walls. When a crack forms, it is secured against pressurised and non-pressurised water by the sealing element. FTS elements are designed for sealing vertical joints used in the prefabricated construction of "white tanks". The joint sealing is also harmonised with the double wall method of construction on the corner joints.

\* Tested up to 5.0 bar; 2.0 bar permitted in accordance with the ETA [European Technical Assessment] and the abP [general test certificate issued by the German Institute for Civil Engineering (DIBt)] (safety factor of 2.5).



# TECHNICAL INFORMATION

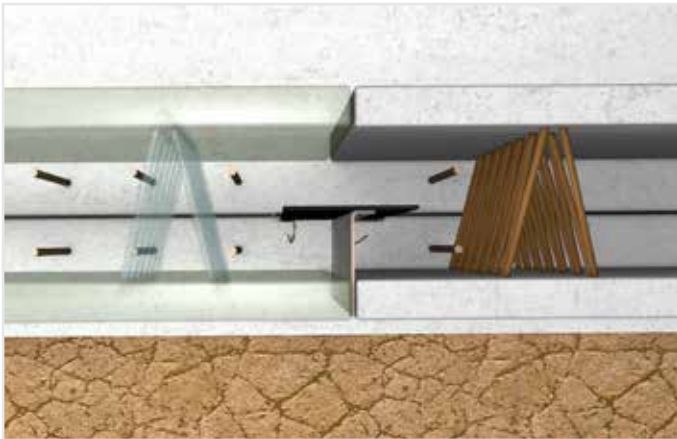

Fig. 1: FTS for straight joint



Fig. 2: FTS Corner for corner joint

## DIMENSIONS



## BASIC INFORMATION

- PENTAFLEX KB® seam sheet
- Element length:  $l = 2.50 \text{ m}; 2.75 \text{ m}; 3.00 \text{ m}$
- Variants for straight slab joint (fig. 1) Variants for slab/corner joint (fig. 2)
- Stock elements for wall thicknesses of 240/250 mm and 300 mm
- Seam sheet overlap at top and bottom for connection to the PENTAFLEX KB®
- Other dimensions on request

## NOTE:

When using PENTAFLEX FTS® Corner elements, PENTAFLEX KB® Corner elements must be installed in the base plate.

# INSTALLATION INSTRUCTIONS



1 Remove all films from the PENTAFLEX FTS® elements. Attach the uncoated wing to the face side of the external formwork and drill through the pre-drilled holes in the element.



2 Fix the PENTAFLEX FTS® element in place using the knock-in anchors supplied.

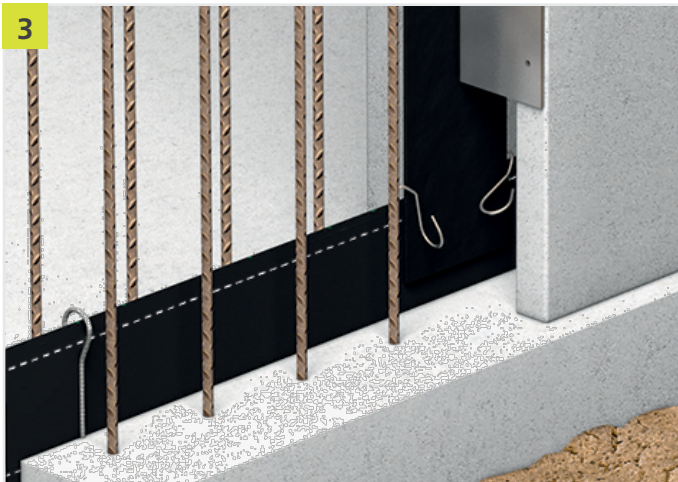

3 Connect the vertically coated seam sheet to the PENTAFLEX KB® in the base plate. To make this connection, overlap by at least 50 mm and press firmly together. Each joint must be secured with two cross clips. At temperatures below +5 °C, the faying surfaces must be heated.

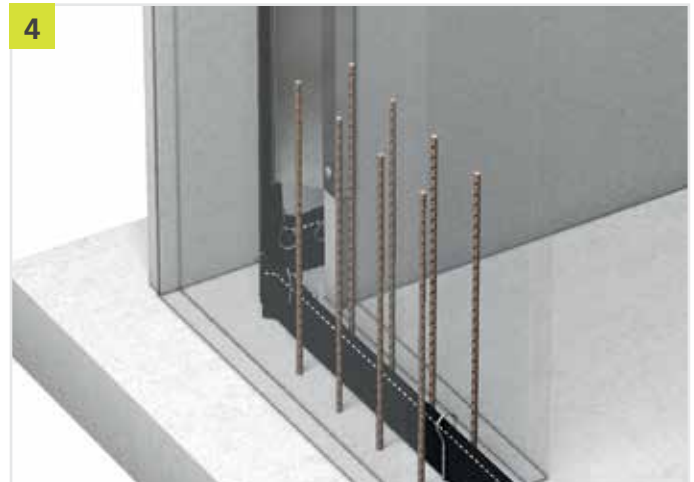

## THE FOLLOWING MUST BE OBSERVED WITH FTS CORNER ELEMENTS:

PENTAFLEX KB® Corner elements must be installed in the base plate. The PENTAFLEX FTS® corner element must be fixed to the inside shell of the prefabricated component in accordance with the above installation instructions. The PENTAFLEX FTS® corner elements must be connected to the base plate using the PENTAFLEX KB® corner element. See point 3. Each joint must be secured with two cross clips.



# INSTALLATION SEQUENCE

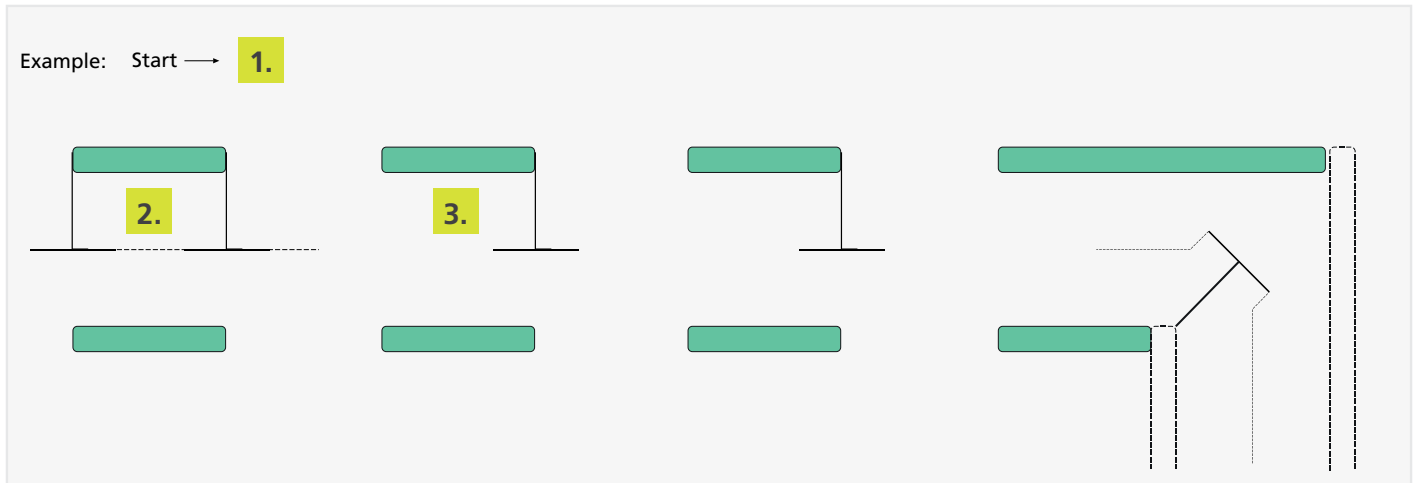

1. Determine the direction of installation of the element walls.

2. Position the first wall element. Secure the PENTAFLEX® FTS elements on both faces of the prefabricated component. Connect the PENTAFLEX® FTS to the PENTAFLEX KB® seam sheet in the base plate.

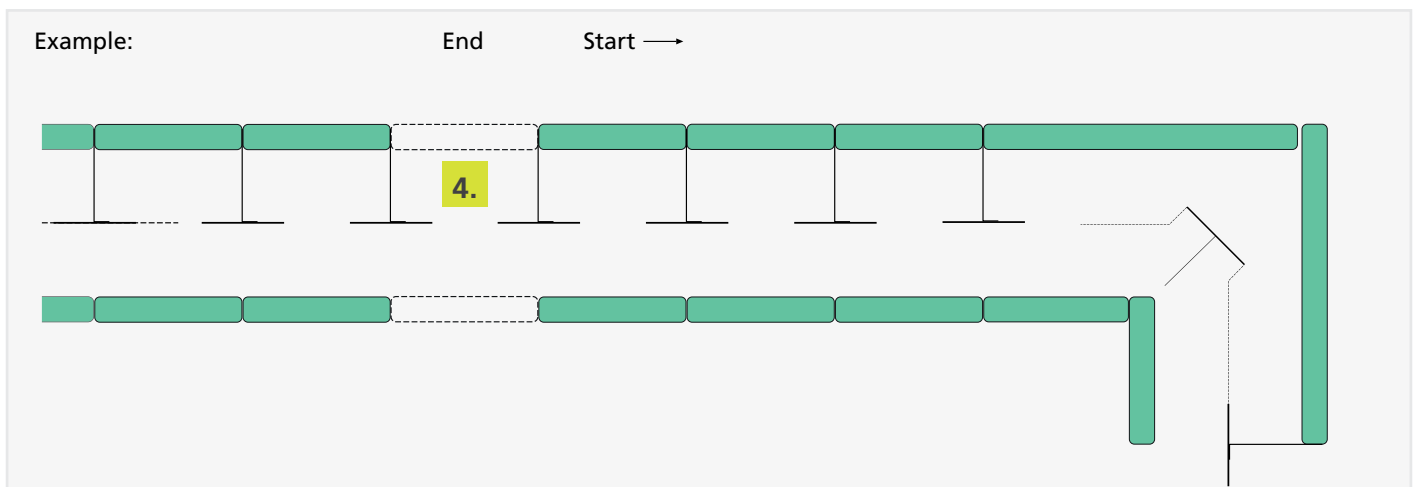

3. Position the next wall element. Attach the PENTAFLEX® FTS to the face of the prefabricated component and connect it to the base plate using the PENTAFLEX KB® seam sheet.

4 The last wall element must be carefully positioned between the wall elements that have already been fitted with PENTAFLEX® FTS elements.

## PENTAFLEX® FTS JOINT FOR STRAIGHT JOINT

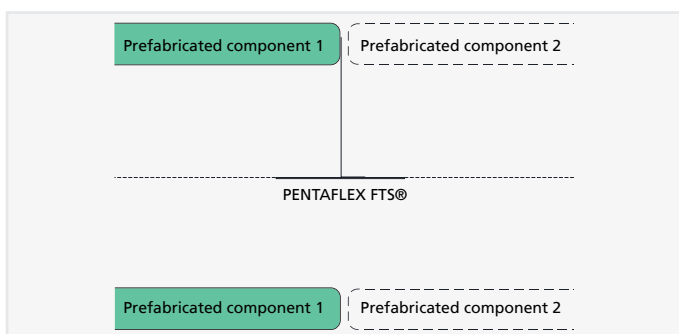

## PENTAFLEX® FTS CORNER FOR CORNER JOINT

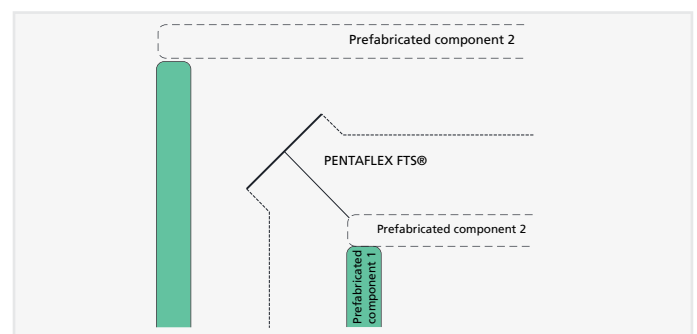



# PENTAFLEX® STK

## SOUND-INSULATING CAGE

### THE PRODUCT

The PENTAFLEX® STK for elements walls is a two-part joint cage element made from galvanised structural steel and hydrophobic soft fibreboard. It prevents concrete bridges from forming and thereby acoustically isolates the wall. The integral stirrups guide the joint tape, prevent collapse during concreting and thus guarantee reliable sealing of the cavity joint.

PENTAFLEX® STK is an elastic sound insulation joint tape with the tried-and-tested PENTAFLEX® coating in the bonding area of the base plate and includes a pre-assembled PENTAFLEX® joint tape connection for connection to the PENTAFLEX KB® in the base/wall joint.

### ADVANTAGES

- Sound insulation tested
- Quick and easy to install
- Reliable sound attenuation
- Reliable sealing of the separating joint
- Easy and reliable connection with the PENTAFLEX KB® joint elements

### APPLICATION AREA

The PENTAFLEX® sound insulation joint system is predominantly used in terraced or semi-detached houses. It can be used either with an element wall construction or for in-situ concrete construction. The houses are insulated acoustically using the PENTAFLEX® STK sound-insulating cage. The building joint is sealed against pressurised and non-pressurised water by the PENTAFLEX® sound insulation joint tape. This results in a closed joint system as required by watertight structure guidelines.

Improvement  
in joint insula-  
tion degree  
 $\Delta K_{ij} = 17.2 \text{ dB}$

# TECHNICAL INFORMATION

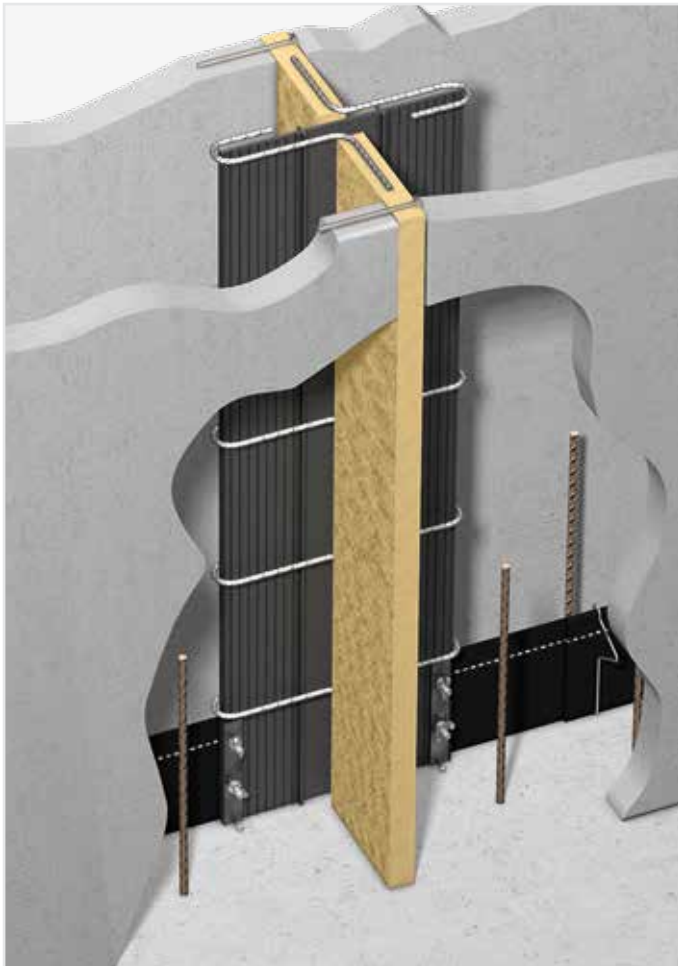

## BASIC INFORMATION

The PENTAFLEX® sound insulation joint reliably performs three tasks:

- Sealing the building joint
- Reliably fixing the PENTAFLEX® sound insulation joint tape
- Acoustic decoupling of components

Separate shuttering in the joint is not required. During concreting, make sure that the element walls and wall formwork are filled evenly on both sides.

## NOTE

It is recommended that a surface seal for protecting the external insulating panel is used to ensure that sound insulation values remain constant in the long term. Other measures are necessary in the area of the base plate and the separating walls of the building. In the case of a separate base plate, the sound-insulating cage can also be inserted horizontally.

## SYSTEM SECTION

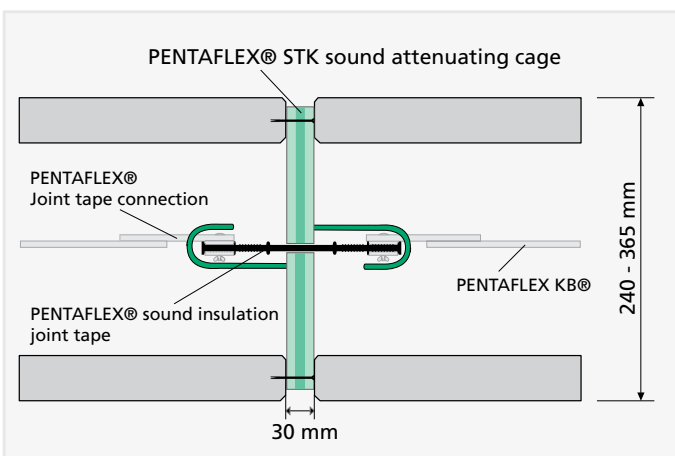

# RANGE



## PENTAFLEX® STK SOUND-INSULATING CAGE

- Two-part sound-insulating cage
- Element length:  $l = 3.00 \text{ m}$
- Delivered ready for installation
- For wall heights  $\leq 2.80 \text{ m}$
- For wall thicknesses 240–365 mm
- Element thickness: 30 mm
- Design dimension of the separating joint: 40 mm



## PENTAFLEX® SFB SOUND INSULATION JOINT TAPE

- Internal PVC joint tape
- Element length:  $l = 3.00 \text{ m}$
- Pre-assembled PENTAFLEX® joint tape connection
- PENTAFLEX® coating (approx. 300 mm) in the bonding area of the base plate
- Supplied complete with omega stirrups and joint clips
- For wall heights  $\leq 2.80 \text{ m}$
- For wall thicknesses  $\geq 240 \text{ mm}$

Peripheral sound insulation joints available on request. Should you require any further assistance, our Application Technology team will be happy to help.

Phone: +49 (0) 7742 9215-300

Fax: +49 (0) 7742 9215-319

E-mail: [technik@h-bau.de](mailto:technik@h-bau.de)



# INSTALLATION INSTRUCTIONS

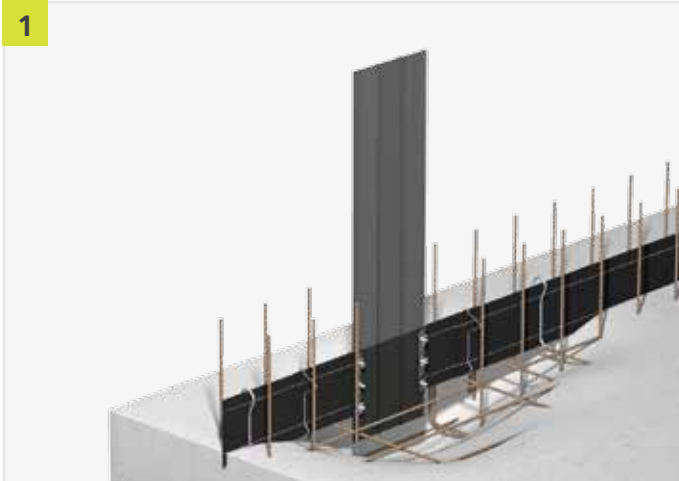

Remove the film at the bottom of the joint tape and on the pre-assembled FBA. The DFA element is attached to the PENTAFLEX KB® running in the base plate by creating an overlap of at least 50 mm, then pressing the two elements firmly together. At temperatures below +5 °C, the faying surfaces must be heated. Secure the joint with a joint clip.

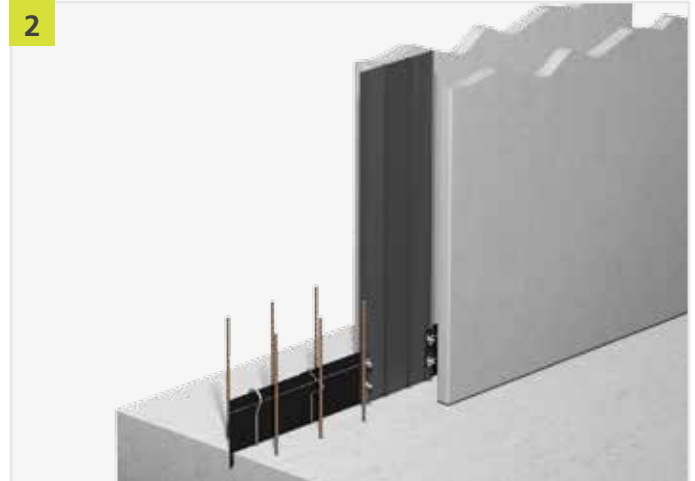

After concreting the base plate, position the wall element.



Before positioning the first sound-insulating cage, remove the plastic strip. Fix the sound-insulating cage to the faces of the element wall using knock-in anchors (6 x 80). Insert the sound insulation joint tape into the stirrups of the sound-insulating cage. Position the second joint cage element. The sound insulation joint tape must also be within the sound-insulating cage in this case. Shorten the sound-insulating cage to the required wall height.



Position the next wall element. Pour the concrete for the element walls. Joint closure on the surface depending on requirements.



# PENTAFLEX® pipe lead- through

LEAK-PROOF  
PENETRATION

## THE PRODUCT

PENTAFLEX® pipe lead-throughs are available in a range of materials. They come equipped with a water stop with the tried-and-tested PENTAFLEX® coating which ensures that no liquid can leak into the surrounding concrete. It is possible to connect a pipe system internally and externally, to pass supply pipes through structural components or to collect surface water internally and direct it into the discharge pipes.

## ADVANTAGES

- Hassle-free installation
- Range of materials
- Compatible with commercially available pipe systems
- Highly cost-effective and efficient

## APPLICATION AREA

PENTAFLEX® pipe lead-throughs can be used for any applications that require watertight penetrations (white tanks) for routing supply and waste pipes through structural components.

PENTAFLEX® pipe lead-throughs can be used in both in-situ concrete construction and prefabricated components. These products demonstrate their versatility and reliability even in walls with internal insulation.



# TECHNICAL INFORMATION

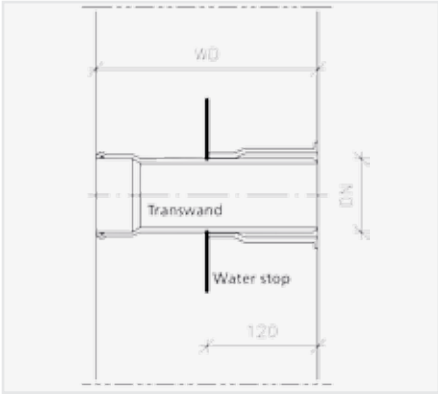

### TRANSWAND

- For attaching pipe sleeves
- Material: PVC/PP
  - DN 110–160
  - PENTAFLEX® water stop
  - Wall thickness
    - Minimum: 200 mm\*
    - Standard: 200, 240, 250, 300 mm

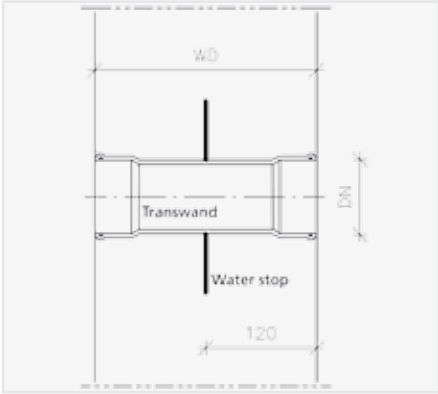

### TRANSWAND DM

- double sleeve
- Material: PVC/PP
  - DN 110–160
  - PENTAFLEX® water stop
  - Wall thickness
    - Minimum: 200 mm\*
    - Standard: 200, 240, 250, 300 mm

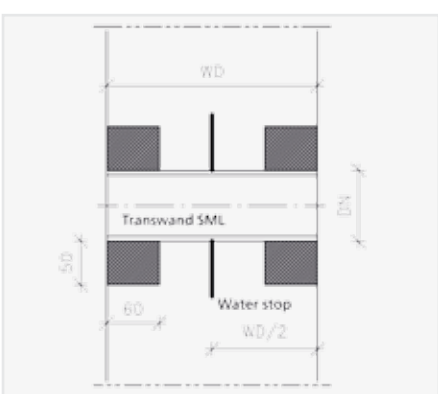

### TRANSWAND SML

- for connecting SML pipes
- Material: Cast steel
  - Polystyrene sleeves
  - DN 100–200
  - PENTAFLEX® water stop
  - Wall thickness
    - Minimum: 200 mm\*
    - Standard: 200, 240, 250, 300 mm

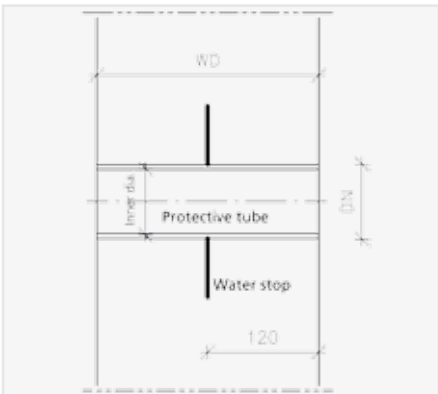

### PROTECTIVE TUBE

- for routing supply pipes through structural components
- Material: PVC/PP
  - DN 110–160
  - PENTAFLEX® water stop
  - Wall thickness
    - Minimum: 200 mm\*
    - Standard: 200, 240, 250, 300 mm

\* Note minimum structural component thickness in accordance with watertight structure guidelines. This is normally 240 mm for walls.

# TRANSWAND/PROTECTIVE TUBE TECHNICAL INFORMATION

## USED IN WALLS WITH INTERNAL INSULATION

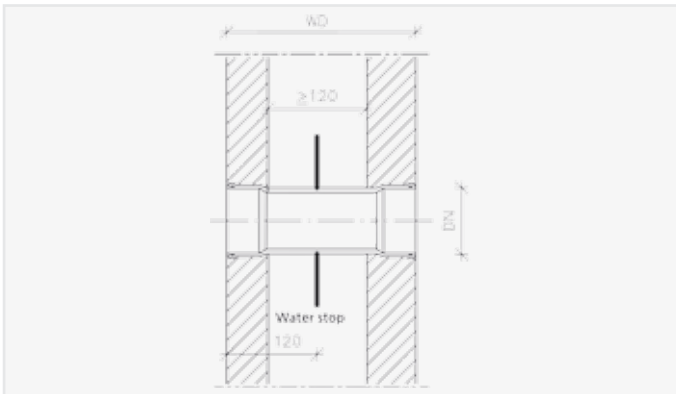

Transwand DM in an element wall

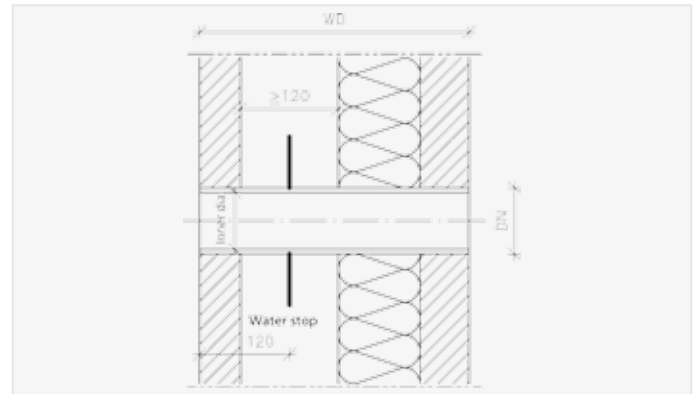

Protective tube in an element wall with internal insulation

## PIPE DIMENSIONS

DN		110		125		160		200	
[mm]		Inner dia.	Outer dia.	Inner dia.	Outer dia.	Inner dia.	Outer dia.	Inner dia.	Outer dia.
Material	PP	103.6	110.0	118.6	125.0	152.0	160.0	190.2	200.0
	PVC	103.2	110.0	117.2	125.0	150.2	160.0	187.6	200.0

DN		100		125		150		200	
[mm]		Inner dia.	Outer dia.	Inner dia.	Outer dia.	Inner dia.	Outer dia.	Inner dia.	Outer dia.
Material	SML	103	110	127	135	152	160	200	210

## INSTALLATION INSTRUCTIONS

- Remove the marked cover.
- Attach the marked cover, as a rule to the external formwork (note the planned connection direction of the on-site pipelines), ensuring precise dimensioning.
- Attach the pipe lead-through to the secured cover.
- If necessary, also fix the pipe in place with tie wire.
- Remove the protective film from the water stop.
- When closing, press the internal formwork against the second cover of the lead-through.
- To connect on-site pipelines, remove the cover on both sides and use the supplied sealing rings.

### NOTE:

Other materials and dimensions available on request



# PENTAFLEX® FLOOR DRAIN TECHNICAL INFORMATION

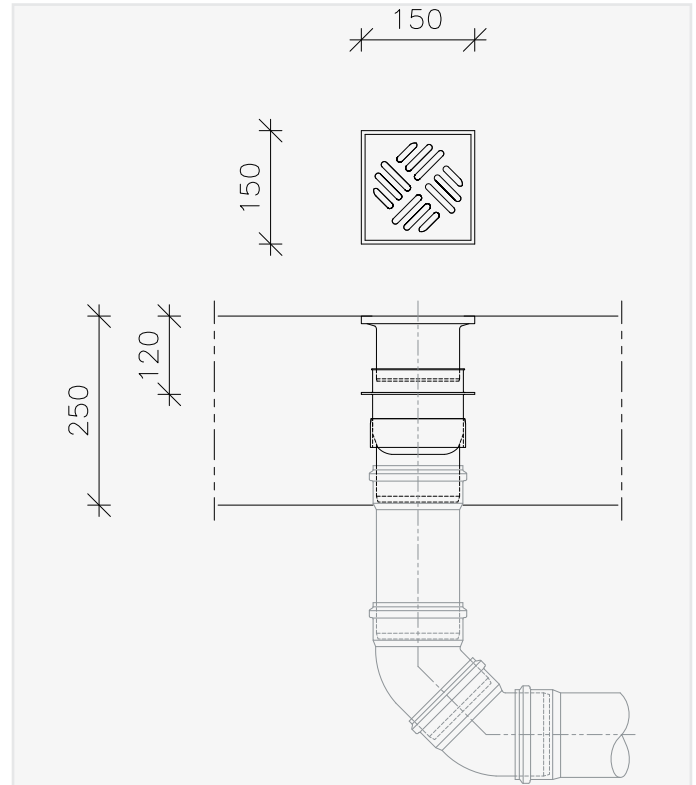

## BASIC INFORMATION

For connecting to pipelines

- Material: PP
- DN 110
- PENTAFLEX® water stop
- 150 x 150 mm attachment piece, height adjustable by 50 mm
- Odour trap (removable)
- Attachment
- 138 x 138 mm slotted grate: ABS, stainless steel or can be tiled
- Load capacity of 0.3 t depending on design, permits traffic

## INSTALLATION INSTRUCTIONS

- Measure the position for the floor drain.
- Lay the ground pipe, ensuring that the outflow is situated vertically upwards correctly.
- Raise the ground pipe to the required height.
- Insert the floor drain into the ground pipe and fix it in place (using the sealing ring).
- Remove the protective film from the water stop.
- Concrete the base plate and check its position.
- Depending on structure of the flooring, the attachment piece may later be pulled out to up to 50 mm.

# PENTAFLEX® FLOOR LEAD-THROUGH TECHNICAL INFORMATION

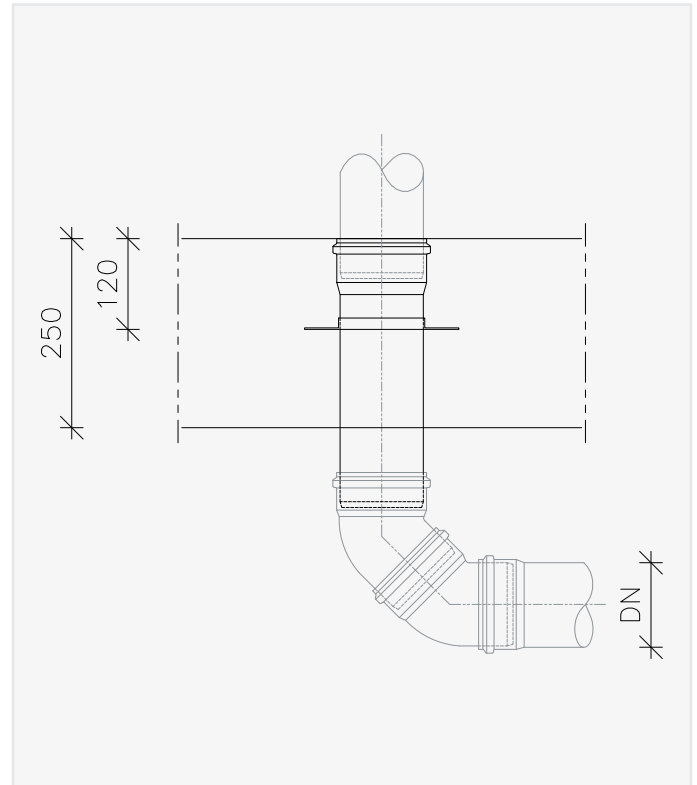

## BASIC INFORMATION

For attaching pipe sleeves

- Material: PVC, PP
- DN 110–160
- PENTAFLEX® water stop
- Pipe length: 500 mm

## INSTALLATION INSTRUCTIONS

- Measure the position for the floor lead-through.
- Lay the ground pipe, ensuring that the outflow is situated vertically upwards correctly.
- Determine the required length of the floor lead-through.
- Shorten the floor lead-through, insert it into the ground pipe and fix it in place (using the sealing ring).
- Insert the cover into the sleeve. Be aware of the risk of contamination.

# PENTAFLEX® ROOF DRAIN TECHNICAL INFORMATION

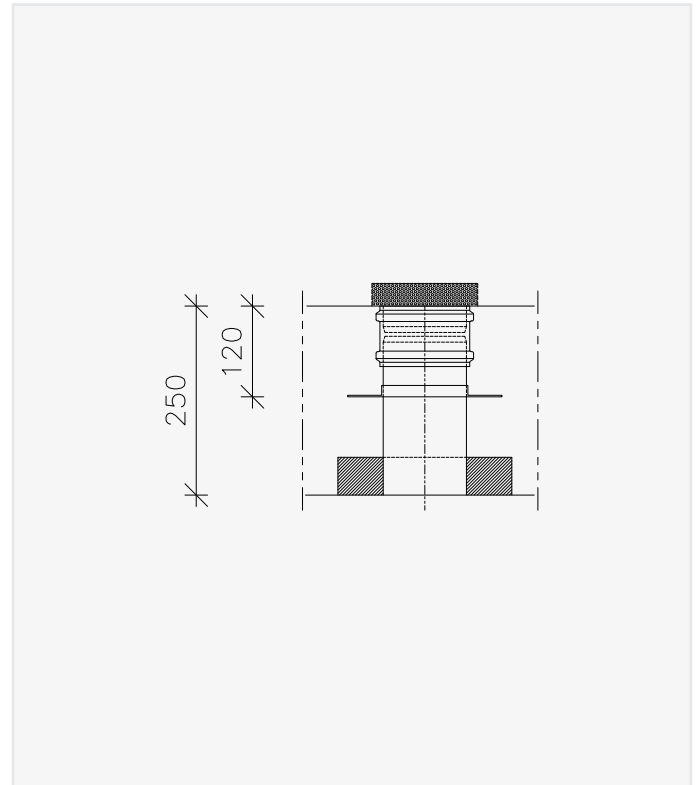

## BASIC INFORMATION

For connecting to pipelines

- Material: PVC
- DN 110
- PENTAFLEX® water stop
- Metal mesh basket

## INSTALLATION INSTRUCTIONS

- Remove the polystyrene cover.
- Attach the cover to the formwork, ensuring precise dimensioning.
- Attach the roof drain to the secured cover.
- If necessary, also fix the roof drain in place with tie wire.
- Remove the protective film from the water stop.
- Concrete the ceiling and check its position.
- To connect on-site pipelines, remove the cover and use the supplied sealing rings.

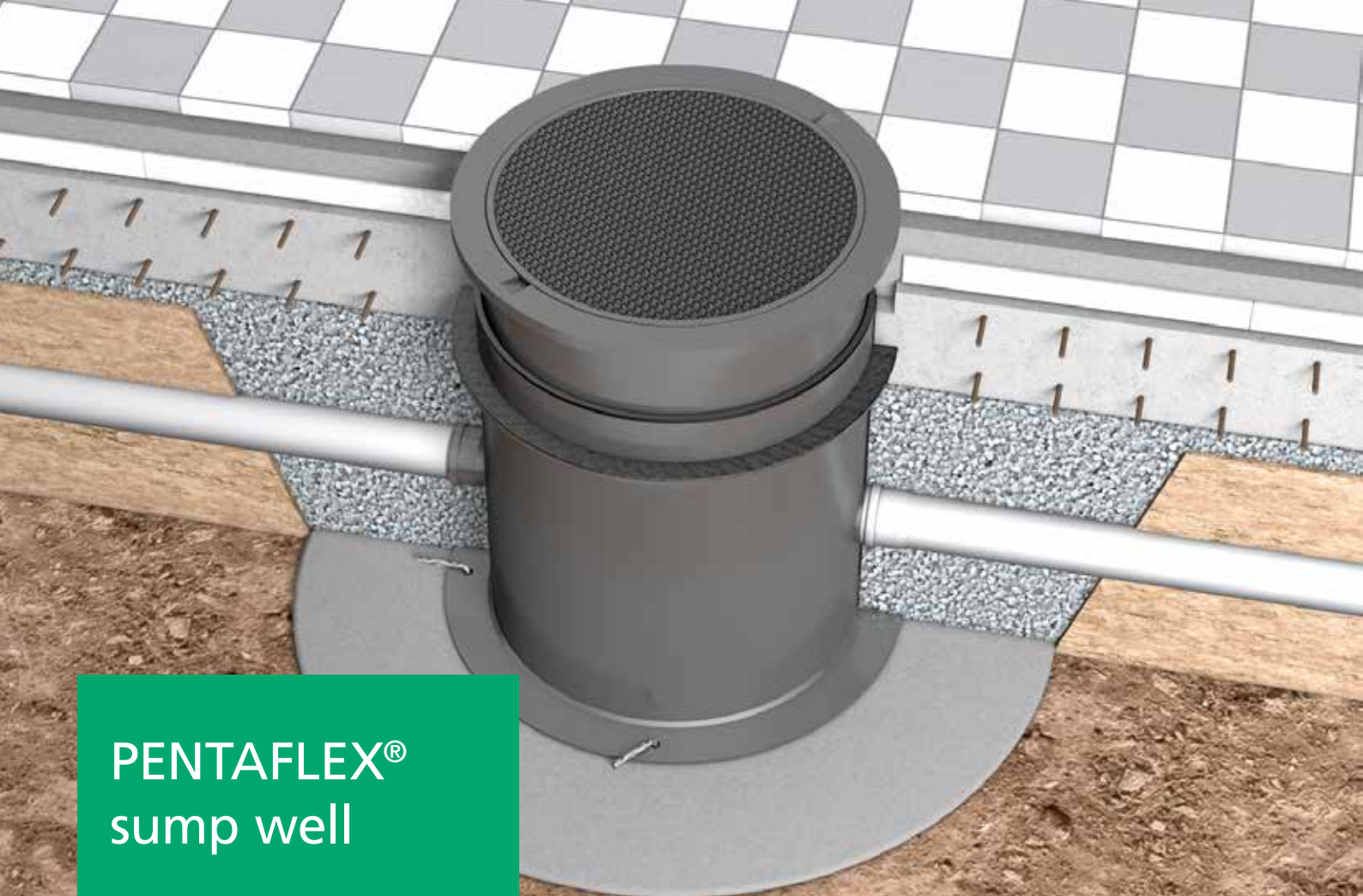

# PENTAFLEX® sump well

## PREFABRICATED WELL

### THE PRODUCT

The characteristic feature of the PENTAFLEX® polyethylene (PE) sump well is its ease of workability. The bottom fixing ring secures this lightweight component to prevent it from floating upwards during concreting. The inlets and outlets are freely selectable, which allows the planner a large degree of freedom. Non-return valves and pumps for grey water can be used. The peripheral water stop with tried-and-tested PENTAFLEX® coating ensures a water-impervious bond with the base plate.

### ADVANTAGES

- Cover with child lock
- Tested by TÜV (Technical Inspection Authority in Germany) and MPA (Institute for Materials Testing in Germany)
- Slip-resistant
- Freely selectable inlets and outlets
- Shaft with telescopic attachment
- High chemical resistance

### APPLICATION AREA

The PENTAFLEX® sump well is used as a collection well around water-impervious components exposed to water. If the effluent water pipes are below the level of the local sewer system, the effluent water must be collected in a sump well and raised to the height of the sewer system using a lifting device.





# TECHNICAL INFORMATION



## BASIC BODIES

- Diameter DN 400 and DN 600
  - DN 400: Height of 500 or 800 mm
  - DN 600: Height of 800 mm
- Material: Polyethylene
- PENTAFLEX® water stop
- Can used at water pressures of up to 0.3 bar
- Inlets and outlets, between DN 50 and DN 160 – Positioning and size in accordance with customer specifications
- High temperature resistance
- Resistant to acids, alkalis, alcohols and oils
- UV resistant

## TELESCOPIC ATTACHMENT

- Height adjustable by 150 mm

## WELL COVER



Type 1: DN 400 Standard cover, surface-watertight



Type 2: DN 400 cover with slotted grate and odour trap



Type 3: DN 400 cover for tiling over, surface-watertight

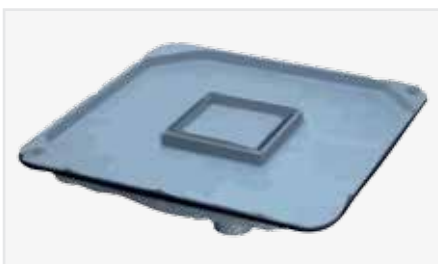

Type 4: DN 400 cover for tiling over, with slotted grate and odour trap

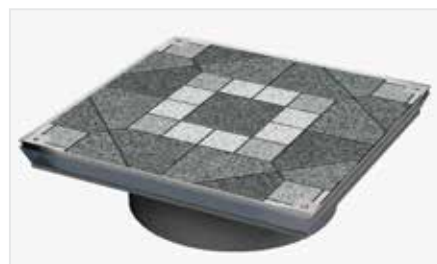

DN 600 telescopic attachment with aluminum frame and sheet-metal tray for tiling over

- DN 400
  - Load class A15 (permits up to 1.5 t of traffic)
  - Slip-resistant surface
  - Dimensions: 400 x 400 mm
  - With child lock

- DN 600
  - Load class A2 (permits up to 200 kg of traffic)
  - Slip-resistant surface
  - Tested by TÜV (Technical Inspection Authority in Germany) and MPA (Institute for Materials Testing in Germany)
  - CE mark
  - Corresponds to the requirements of ISO 15398
  - UV resistant
  - Dimensions: 800 x 800 mm
  - With child lock

**NOTE:**  
Installation instructions at [www.h-bau.de](http://www.h-bau.de)



## PENTAFLEX® OPTI wall strengtheners

### TIE POINT

#### THE PRODUCT

PENTAFLEX® OPTI wall strengtheners comprise a plastic tube with an internal diameter of 22 mm and integrated water stops. In addition, the wall strengthener is provided with the tried-and-tested PENTAFLEX® coating for a watertight bond between the tie point and the concrete. Sealing plugs and OPTI stoppers turn the PENTAFLEX® OPTI wall strengthener into an easily manageable, pressurised water-resistant tie point.

#### ADVANTAGES

- Tested for watertightness: Up to 5 bar in the direction of stopper insertion
- Additional reliability thanks to the tried-and-tested PENTAFLEX® coating
- Can be closed immediately after stripping the formwork
- Installation and closure independent of the weather

#### APPLICATION AREA

PENTAFLEX® OPTI wall strengtheners are specially designed for use as watertight formwork tie points for water-impervious concrete structural elements. They are available for all existing wall thicknesses in the range of water-impervious components.

# TECHNICAL INFORMATION

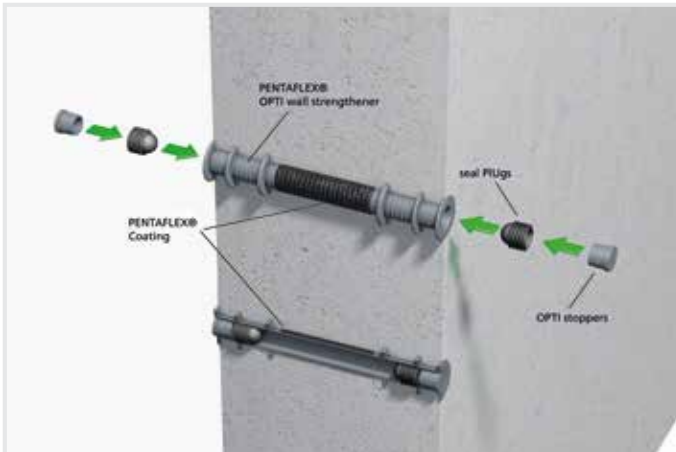

## BASIC INFORMATION

- Plastic tie points with integrated water stops
- Available as standard in lengths of 240 mm, 250 mm, 300 mm, 350 mm, 365 mm and 400 mm
- Inner diameter of 22 mm
- Blanking plugs included in the delivery
- Other dimensions on request

## INSTALLATION INSTRUCTIONS

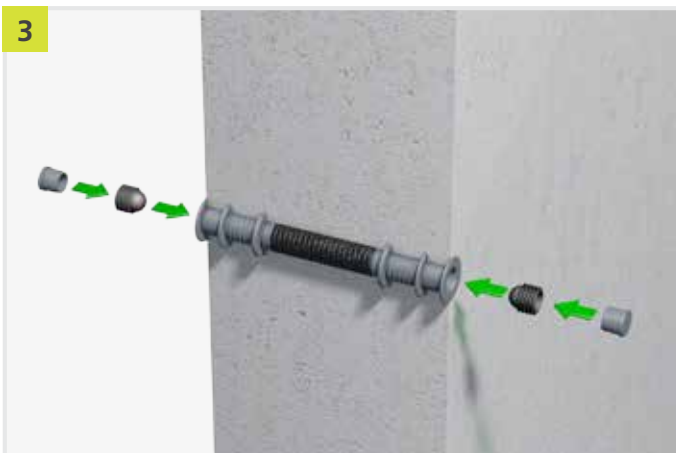
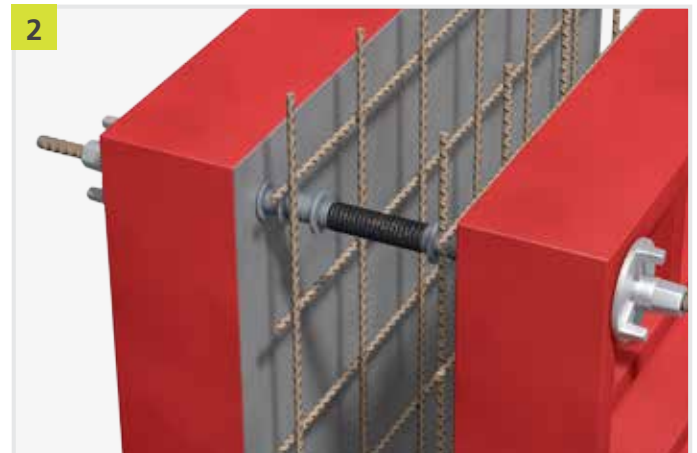



# PENTABOX

## REINFORCEMENT ATTACHMENT

### THE PRODUCT

PENTABOX is a FERBOX® rebend connection combined with the PENTAFLEX® sealing system designed for the construction of watertight concrete structures (white tanks). Compared to conventional reinforcement attachments, PENTABOX offers the highest possible protection against leaks in the joint area.

In order to prevent water seepage along the flashing box, FERBOX® flashing boxes are coated with PENTAFLEX® on both sides in the factory. This also enables watertight rebend connections to be made easily.

### ADVANTAGES

- Hydrostatically sealed
- Protection against water permeability thanks to the tried-and-tested PENTAFLEX® coating on both sides
- Hassle-free installation
- Meets all requirements for rebend connections

### APPLICATION AREA

PENTABOX is used in all areas where there is contact with water. The application areas are wall and ceiling attachments, console attachments for wall projections or stretched consoles and light shaft attachments.



# TECHNICAL INFORMATION

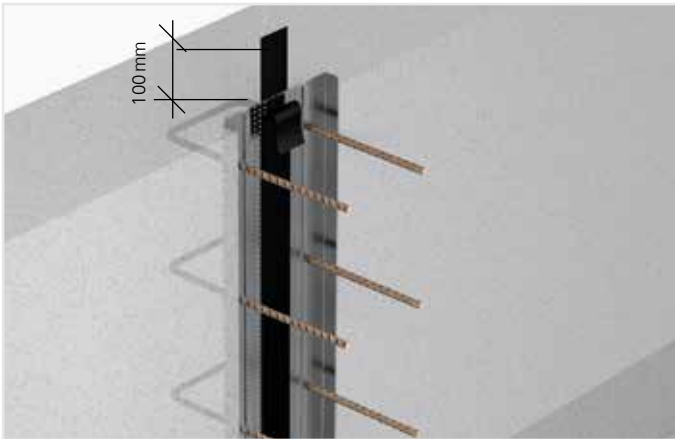

## BASIC INFORMATION

- The PENTABOX reinforcement attachments are available as FERBOX® type B and special types
- For the dimensions of the flashing box and reinforcement density, refer to the "Reinforcement" technical information
- Sealing via tried-and-tested PENTAFLEX® coating
- PENTABOX reinforcement attachments are connected together using the PENTAFLEX® strip protruding on both sides

## INSTALLATION INSTRUCTIONS

- The PENTABOX reinforcement attachment must be immovably fixed in the correct position on the formwork by:
  - Nailing it firmly to the wooden formwork
  - Riveting it to the metal formwork
  - Welding or connecting it to the existing reinforcement
- The next PENTABOX must be placed flush against it and fixed to the formwork.
- The protruding PENTAFLEX® strip must be connected together (pull back the film and stick the strip together).
- Remove the protective film from the PENTAFLEX® strip, lay the reinforcement for the first wall section, place the formwork and then concrete.
- After removing the formwork, remove the cover.
- Remove the stoppers from the ends of the box.
- Reverse bend the reinforcement rods in accordance with DBV bulletin "Reverse bending of reinforcing steel and requirements for flashing boxes".
- Do not treat the flashing box remaining in the joint with formwork release oil.
- Remove any concrete debris
- Connect the protruding PENTAFLEX® strip together (pull back the film and stick the strip together).
- Remove the protective film from the PENTAFLEX® strip and lay the reinforcement for the second wall section, place the formwork and then concrete.

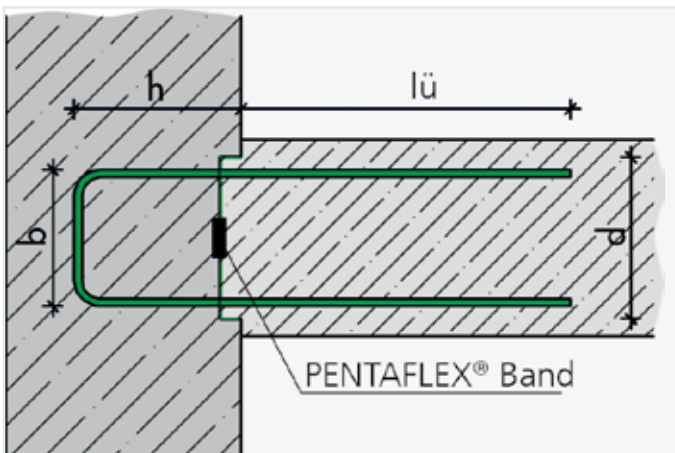

### NOTE:

More information, dimensions and data regarding FERBOX® rebend connections can be found in the technical information or online at [www.h-bau.de](http://www.h-bau.de).



# DESIGN AND CONSTRUCTION OF WATER-IMPERVIOUS CONCRETE STRUCTURES\*

## BASIC PRINCIPLES

To prevent ingress of water into structures, water-impervious reinforced concrete structures known as "white tanks" have been built for over 30 years. Thanks to many years of practice and experience, this method of construction is an economical way of providing protection against pressing water. The watertight structure guidelines set out the generally accepted technical rules and standards for this type of structure.

The water imperviousness of a structure is defined by its ability to prevent or limit water seepage through concrete, construction joints, crack control joints, expansions joints, assembly elements and cracks.

### THIS MEANS THAT:

- All joints must be sealed
- The concrete must satisfy stringent requirements
- Minimum component thicknesses must be complied with
- Separating cracks must be avoided
- The crack width in structural components must be limited
- The pressure zone must have a minimum height
- Construction joints, crack control joints and expansion joints must be arranged and formed as planned

## AREA OF APPLICATION

- The watertight structure guidelines apply to base plates, walls, ceilings (no intermediate ceilings) and roofs
- The watertight structure guidelines apply analogously to tanks, retaining walls and underground civil engineering structures
- The watertight structure guidelines do not apply to ZTV-ING structures, ZTV-W structures, concrete prefabricated garages and containers

## PLANNING TASKS

The usage requirements and necessary arrangements for the structure's fitness for purpose and stability are defined and implemented during planning. The project planner is responsible for this.

### THIS INCLUDES

- Project planner/architect (coordinator)
- Geotechnical engineer
- Structural engineer
- Contractor (work scheduling)
- Client
- Building physicist
- Structural engineer planner
- Expert planner (specialist)

## THE FOLLOWING TASKS AND MEASURES MUST BE CONSIDERED

- Needs planning
- Type of stress (soil analysis)
- Type of usage and start of usage
- Component-related design principles
- Structural, concreting and implementation measures according to the design principle
- Component dimensions
- Planning a joint sealing system
- Planning assembly components and penetrations
- Water-imperviousness concept
- Documentation of all specifications

## SPECIFICATIONS

Water seepage through concrete, joints, assembly components and cracks must be limited in accordance with the watertight structure guidelines.

### STRESS CLASSES

There are two stress classes. The difference between them lies in whether there is water against the structure or whether there is merely moisture in the soil and/or water flowing around it.

Stress class 1	Stress class 2
<ul style="list-style-type: none"> <li>■ Constant or occasional pressing water</li> </ul>	<ul style="list-style-type: none"> <li>■ Soil moisture and free-flowing water by the wall</li> </ul>

### USAGE CLASSES

The watertight structure guidelines distinguish between two usage classes. These are defined by the intended use, the required indoor climate and the moisture level of the component's surface.

Usage class A	Usage class B
<ul style="list-style-type: none"> <li>■ No damp spots caused by water seepage on the side of the component's surface exposed to air</li> <li>■ No cracks or joints channelling water</li> </ul>	<ul style="list-style-type: none"> <li>■ Damp spots on the side of the component's surface exposed to air are permitted</li> <li>■ Temporary and self-healing water-channelling cracks</li> <li>■ No accumulation of water on the component's surface</li> </ul>
Application examples: <ul style="list-style-type: none"> <li>■ Standard for residential buildings and offices</li> <li>■ Storage rooms designed for high-value purposes</li> </ul>	Application examples: <ul style="list-style-type: none"> <li>■ Single garages, underground car parks</li> <li>■ Installation and supply shafts</li> <li>■ Utility rooms</li> <li>■ Storage rooms with low requirements</li> </ul>

\*) Source: DAfStb guidelines "Watertight structures made of concrete" and DAfStb data sheet 555 "Notes on the DAfStb guidelines "Watertight structures made of concrete".

## DESIGN PRINCIPLES

### AVOIDING SEPARATING CRACKS

Force stressing in concrete, which can result in the formation of water-channelling separating cracks, is avoided using suitable structural, concreting and implementation measures.

### SPECIFYING THE WIDTH OF SEPARATING CRACKS

This principle is designed to control and/or predefine the crack width by providing extra reinforcement for the concrete structure. Water seepage is limited by the concrete self-healing.

### SPECIFYING THE WIDTH OF SEPARATING CRACKS IN COMBINATION WITH SEALING MEASURES

The third design principle is based on the minimum requirements for the theoretical width of the separating crack set out in DIN EN 1992-1-1. Water-channelling cracks are subsequently sealed using the intended sealing measures planned.

## REQUIREMENTS FOR THE CONCRETE AND DESIGN

To select a suitable concrete, the requirements for the exposure class that applies to the structural component (specified in DIN EN 1992-1-1/NA) must be complied with and the requirements for a concrete with a high resistance to water penetration (specified in DIN EN 206-1 and DIN 104-2) must be taken into account.

Sufficient workability can be guaranteed by using consistency class F3 or softer. When designing water-impervious components with the minimum component thicknesses, an adequate water/cement ratio of  $\leq 0.55$  must be used for stress class 1; for structural components that are walls, the maximum particle size that may be used is  $\leq 16$  mm. At a height of fall of greater than 1 m or with

element walls that have the minimum wall thickness, an attachment mixture (largest particle  $\leq 8$  mm) must be used in the base area at a height of  $\geq 300$  mm in order to ensure that the concrete is laid with zero defects.

### STRUCTURAL COMPONENT THICKNESS

The following minimum thicknesses of structural components are specified in the watertight structure guidelines based on many years of experience with in-situ concrete and prefabricated components.

The minimum thickness and construction of the structural components must therefore be selected such that the concrete structural components can be concreted properly, taking the concrete covering, the required reinforcement layers, the joint seals and the assembly elements into account. Besides being weight-bearing and sealing, components must also possess all the other characteristics required of them.

In addition to the minimum dimensions, there are special requirements for the clear inside dimension  $b_{w,i}$  to ensure concretability and professional installation of the inner joint seal: These apply to in-situ concrete walls between the layers of reinforcement and to element walls without reinforcement in the in-situ concrete topping between the inside surfaces of the prefabricated slabs.

- For a maximum particle size of 8 mm  $b_{w,i} \geq 120$  mm
- For a maximum particle size of 16 mm  $b_{w,i} \geq 140$  mm
- For a maximum particle size of 32 mm  $b_{w,i} \geq 180$  mm

If the resulting component thicknesses are larger than the minimum dimension in the table below, the resulting component thicknesses take precedence.

Type	Stress class	Minimum thickness in [mm]		
		In-situ concrete	Element walls	Prefabricated components
Walls	1	240	240 (120 <sup>b</sup> )	200
	2	200	240 <sup>a</sup> (120 <sup>b</sup> )	100
Base plate	1	250	–	200
	2	150	–	100
Roofs without thermal insulation	1	200	240 (180 <sup>b</sup> )	180
Roofs with thermal insulation	1	180	220 (160 <sup>b</sup> )	160

<sup>a)</sup> This can be reduced to 200mm if particular concreting and implementation measures are taken

<sup>b)</sup> Minimum values for the in-situ concrete topping. Section 7.1 (2) applies to water-impervious concrete. With additional reinforcement and inside joint seals, the additional requirements for the clear inside dimensions set out in Section 7.2 (3) may need to be met.

## CALCULATION AND DIMENSIONING

### EFFECTS

- Direct effects (loads)
- Indirect effects (temperature, shrinkage, settlements)
- Chemical and physical effects (classification into exposure classes)

### STORAGE CONDITIONS

- Subgrade, insulation, subbase, sliding layers

### FORCE

- Through fully for partially or impeded deformation
- From atmospheric factors

### PROOF

Proof of water imperviousness is an additional proof of fitness for purpose for DIN 1045-1, Section 5.4.1, Paragraph 2.

### BASICS

Proof depending on the design principle.

For bending cracks resulting from loads and forces, it is necessary to prove for usage class A, stress class 1, that the pressure zone height ( $x$ ) fulfils the condition  $x \geq 30 \text{ mm}$  and  $\geq 1.5 D_{\text{max}}$  where  $D_{\text{max}}$  is the maximum aggregate particle diameter.

Alternative: Limit the width of bending cracks ( $w_k$  in Table 2)

Table 2: Theoretical separating crack widths for usage class B and the design principle if water seepage should be limited by the cracks self-healing.

Pressure gradient $h_w/h_b^*$	Maximum head of the water $h_w^a$	Permissible crack width $w_k^b$
10	3.0 m	0.20 mm
> 10 to $\leq 15$	6.0 m	0.15 mm
> 15 to $\leq 25$	10.0 m	0.10 mm

<sup>a</sup>  $h_w$  = head of the water in m;  $h_b$  = component thickness in m

<sup>b</sup> For aggressive water with  $>40 \text{ mg/l CO}_2$  (lime-dissolving carbon dioxide) or a pH of  $<5.5$ , self-healing of the cracks must not be taken into account

### PROOF OF DESIGN PRINCIPLE A

The characteristic tensile strength of the concrete must not exceed the central tensile stress at any time

### PROOF OF DESIGN PRINCIPLE B

See the table of theoretical separating crack widths for usage class B and the design principle if water seepage should be limited by the cracks self-healing.

### PROOF OF DESIGN PRINCIPLE C

Theoretical crack width  $w_k = 0.30 \text{ mm}$  with XC2/XC3

### PROOF OF USAGE CLASS A

The required proofs are based the selected design principle of usage class A. In this case, it must be verified that no separating cracks occur in the concrete as a result of force. The exceptions here are the planned, sealed joints. This includes the crack control, construction and expansion joints which cause a reduction in the force on the structural components as a result of their arrangement at spacings that are to be specified. The widths of the cracks that occur are limited by the design of the pre-crack dummy and construction joints and/or layout of the reinforcement.

**Example** of usage class A: Standard for residential buildings and rooms designed for high-value purposes.

### PROOF OF USAGE CLASS B

The required proofs are based the selected design principles of usage class B. Its requirements are met by limiting the width of separating cracks with the assumption that the cracks are self-healing. The widths of the cracks that occur are limited by the design of the pre-crack dummy and construction joints and/or layout of the reinforcement.

**Example** of usage class B: Single garages, underground car parks and storage rooms with low requirements

## REINFORCEMENT AND DESIGN RULES

The layout of the reinforcement in the structural components must be designed to allow the fresh concrete to be laid and compacted correctly. Water-impervious components of stress class 1 should be made with two-layer reinforcement mesh composed of criss-crossing reinforcing elements. This is not required for prefabricated components of stress class 2. The construction joints must be defined by the planner and presented as a draft design.

In accordance with the defined stress and usage class, all joints in water-impervious components must be permanently protected by a continuous and consistent joint sealing system that is impermeable to water.

Crack control joints are caused by sufficiently weakening the concrete cross-section (at least 1/3 of the structural component's thickness) and must be sealed accordingly.

Special crack control elements guarantee that both requirements are met, making them suitable for structures of usage class A. Element wall joints should generally be designed as crack control joints.

## JOINT SEALS

Only products the intended purpose of which is verified by a proof of usability certificate may be used for joint seals in water-impervious components. All of the joint seals that engage with the concrete must be precisely placed according to the design, connected to the joints and forcefully and permanently secured in position prior to concreting.

Sealing system	Regulations set out in the watertight structure guidelines
Joint tapes in accordance with DIN 7865 and DIN 18541	Usage in accordance with DIN 18197
Non-coated seam sheets in accordance with DIN EN 10051	Usage according to Section 10.2 of the watertight structure guidelines
Unregulated construction products: <ul style="list-style-type: none"> <li>■ Joint tapes in accordance with the company standard</li> <li>■ Combination construction joint tapes</li> <li>■ Outer strip-shaped joint seals</li> <li>■ Coated seam sheets</li> <li>■ Leaktight pipes</li> <li>■ Compressed injection hoses</li> <li>■ Swellable joint inserts</li> </ul>	Proof of usability is required ETA – European Technical Assessment AbP – General supervisory test certificate

## CONSTRUCTION

### GENERAL INFORMATION

Reinforcement work, concreting, curing and construction supervision are carried out in accordance with DIN EN 13670 in conjunction with DIN 1014-3.

### SPACERS AND FORMWORK ANCHORS

The spacers and formwork anchors used must not affect the water-imperviousness of the structure locally (see DBV instruction leaflets "Spacers/supports in accordance with EC 2").

### SEALING CRACKS AND REPAIRING DEFECTS

Cracks, leaking joints and permeability in the concrete structure must be sealed as described in the DAFStb guideline "Protecting and repairing concrete components".

### MANUFACTURE, DELIVERY AND INSTALLATION OF PREFABRICATED COMPONENTS AND SEMI-PREFABRICATED COMPONENTS; LAYING OF THE IN-SITU CONCRETE

- Surfaces for in-situ concreting must be conditioned to guarantee a pore-free bond
- This means that the entire bonding surface must have a rough grain
- The average surface roughness must be at least 1.5 mm
- Proper installation must be ensured
- Construction joints must be cleaned of impurities before installation
- Element wall panels must be elevated by at least 30 mm
- The inside surfaces must be sufficiently pre-wetted before concreting the core concrete
- The surface temperature of the element wall must be more than 0 °C
- The core concrete is laid in layers, generally 500 mm high
- Comply with the concreting speed specified by the manufacturer
- Careful compaction must be ensured
- All measures must be documented accordingly







# FORWARD CONSTRUCTING: WE ARE ALWAYS THERE FOR YOU.

You can rely on our excellent service: We accompany you through every phase of the project – either over the phone, online or in person, directly at your site. As a true partner, we place special value on offering our customers added value – take a look at our comprehensive range of services and see for yourself.



## READY TO GO: OUR TENDER DOCUMENT TEMPLATES.

Our tender document templates can be quickly and easily embedded in your tender program, e.g. with the tender managers at [www.ausschreiben.de](http://www.ausschreiben.de) or [www.heinze.de](http://www.heinze.de).

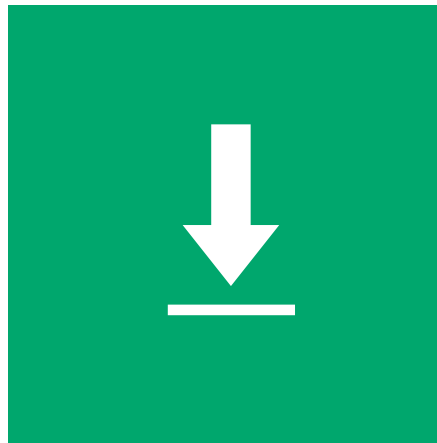

## EVERYTHING ONLINE: OUR DOWNLOAD AREA.

You can download all brochures, test reports, approvals, our current price list and much more from our website.



## FOR PLANNING AND APPLICATION: OUR VIDEOS AND SOFTWARE.

In addition to our installation and reference films, we also provide you with various software solutions, such as calculation programs, free of charge on our website.



## HOTLINES

Personalised support when planning and executing projects:

Answers to any questions you have about delivery times, shipping, sales prices and the entire process of fulfilling your orders:

### APPLICATION TECHNOLOGY

Hotline: +49 (0) 7742 9215-300  
E-mail: [technik@h-bau.de](mailto:technik@h-bau.de)

### SALES (GERMANY)

Hotline: +49 (0) 7742 9215-200  
E-mail: [vertrieb@h-bau.de](mailto:vertrieb@h-bau.de)



**TAILOR-MADE:  
OUR SPECIAL CONSTRUCTIONS.**

Unable to find what you're looking for in our wide range of products and services? Our engineers and applications specialists can develop tailor-made product solutions for you on request.

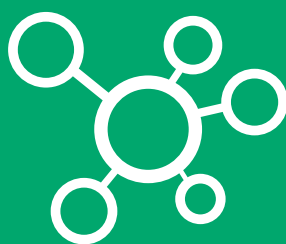

**FROM PERSON TO PERSON:  
OUR NETWORK OF CONSULTANTS.**

Get the answers to your technical questions face-to-face at your site: Our consultant engineers will be happy to come to your site.



**THE LATEST NEWS:  
OUR NEWSLETTER.**

Subscribe to our newsletter and you will always be kept up-to-date: Find out more about our product innovations, trade shows and current trends in the sector.

Answers to any questions you have about delivery times, shipping, sales prices and the entire process of fulfilling your orders at an international level:

**SALES (INTERNATIONAL)**

Hotline: +49 (0) 7742 9215-250  
E-mail: [export@h-bau.de](mailto:export@h-bau.de)

We will be happy to send you our technical brochures and planning documents:

**HEAD OFFICE**

Hotline: +49 (0) 7742 9215-0  
E-mail: [info@h-bau.de](mailto:info@h-bau.de)

# FORWARD CONSTRUCTING CONTACTS: WE WILL BE WHEREVER YOU ARE.

Thanks to our global sales network, expert specialist advisors are available to you on a national level and on an international level. If there is no contact partner listed for your country, contact our Head Office in Klettgau – we will be happy to provide you with further assistance.



## HEAD OFFICE

### H-BAU TECHNIK GMBH

Am Güterbahnhof 20  
79771 Klettgau, Germany  
Phone: +49 (0) 7742 9215-0  
Fax: +49 (0) 7742 9215-129  
E-mail: [info@h-bau.de](mailto:info@h-bau.de)  
[www.h-bau.com](http://www.h-bau.com)

### PRODUCTION: NORTH-EAST

Brandenburger Allee 30  
14641 Nauen OT Wachow, Germany  
Phone: +49 (0) 33239 775-0  
Fax: +49 (0) 33239 775-90  
E-mail: [info.berlin@h-bau.de](mailto:info.berlin@h-bau.de)

### PRODUCTION CHEMNITZ

Beyerstraße 21  
09113 Chemnitz, Germany  
Phone: +49 (0) 371 40041-0  
Fax: +49 (0) 371 40041-99  
E-mail: [info.chemnitz@h-bau.de](mailto:info.chemnitz@h-bau.de)

## JORDAHL H-BAU VERTRIEBS GMBH

Our products are sold in Germany exclusively through the following subsidiaries of JORDAHL H-BAU Vertriebs GmbH:

### ESSEN

JORDAHL H-BAU Vertriebs GmbH  
Carnaperhof 7  
45329 Essen, Germany  
Phone: +49 (0) 201 289660  
Fax: +49 (0) 201 2896620  
E-mail: [essen@jordahl-hbau.de](mailto:essen@jordahl-hbau.de)

### NUREMBERG

JORDAHL H-BAU Vertriebs GmbH  
Lechstraße 21  
90451 Nuremberg, Germany  
Phone: +49 (0) 911 6412980  
Fax: +49 (0) 911 6496099  
E-mail: [nuernberg@jordahl-hbau.de](mailto:nuernberg@jordahl-hbau.de)

### MANNHEIM

JORDAHL H-BAU Vertriebs GmbH  
Markircher Straße 14  
68229 Mannheim, Germany  
Phone: +49 (0) 621 4840340  
Fax: +49 (0) 621 4840344  
E-mail: [mannheim@jordahl-hbau.de](mailto:mannheim@jordahl-hbau.de)

You are also welcome to contact our Head Office in Klettgau directly.

## GLOBAL PARTNERS

**SWITZERLAND**

JORDAHL H-BAU AG  
 Wasterkingergweg 2  
 8193 Eglisau, Switzerland  
 Phone: +41 (0) 44 8071717  
 Fax: +41 (0) 44 8071718  
 E-mail: info@jordahl-hbau.ch  
 www.jordahl-hbau.ch

**AUSTRIA**

JORDAHL H-BAU  
 Österreich GmbH  
 Straubingstrasse 19  
 4030 Linz, Austria  
 Phone: +43 (0) 732 321900  
 Fax: +43 (0) 732 321900-99  
 E-mail: office@jordahl-hbau.at  
 www.jordahl-hbau.at

**FRANCE**

JORDAHL H-BAU France SARL  
 Siège  
 7 rue des Vallières Sud  
 25220 Chalezeule, France  
 Phone: +33 (0) 381 250465  
 Fax: +33 (0) 381 250796  
 E-mail: info@jordahl-hbau.fr  
 www.jordahl-hbau.fr

**NETHERLANDS**

JORDAHL H-BAU  
 Bezoekadres  
 Jan Tinbergenstraat 221  
 7559 SP Hengelo, Netherlands  
 Phone: +31 (0) 74 2505737  
 Fax: +31 (0) 74 2503321  
 E-mail: info@jordahl-hbau.nl  
 www.jordahl-hbau.nl

**DENMARK**

Jordahl & Pfeifer Byggeteknik A/S  
 Risgårdevej 66  
 9640 Farsø, Denmark  
 Phone: +45 (0) 98 631900  
 Phone: +45 (0) 98 631939  
 E-mail: info@jordahl-pfeifer.dk  
 www.jordahl-pfeifer.dk

**HUNGARY**

PFEIFER Garant Kft.  
 Gyömrői út 128  
 1103 Budapest, Hungary  
 Phone: +36 (0) 1 2601014  
 Fax: +36 (0) 1 2620927  
 E-mail: info@pfeifer-garant.hu  
 www.pfeifer-garant.hu

**UNITED KINGDOM**

J&P Building Systems Ltd.  
 Unit 5  
 Thame Forty  
 Jane Morbey Road  
 THAME, OXON OX9 3RR, UK  
 Phone: +44 (0) 1844 215200  
 Fax: +44 (0) 1844 263257  
 enquiries@jandpbuildingsystems.com  
 www.jp-uk.com

**UKRAINE**

JORDAHL & PFEIFER  
 Technika Budowlana  
 ul. Pawlyka 17a  
 76-018 Ivano-Frankivsk, Ukraine  
 Phone Reg. East: +380 (0) 67442 8578  
 Phone Reg. West: +380 (0) 67442 8579  
 E-mail: info@j-p.com.ua

**CZECH REPUBLIC**

Jordahl & Pfeifer  
 Stavební technika s.r.o.  
 Bavorská 856/14  
 15500 Prague 5, Czech Republic  
 Phone: +420 (0) 272 700701  
 Fax: +420 (0) 272 700704  
 E-mail: info@jpcz.cz  
 www.jpcz.cz

**SPAIN**

PFEIFER Cables y Equipos de Elevación, S.L.  
 Avda.de Los Pirineos, 25 – Nave 20  
 San Sebastian de los Reyes  
 28700 Madrid, Spain  
 Phone: +34 (0) 91 659 3185  
 Fax: +34 (0) 91 659 3139  
 E-mail: p-es@pfeifer.de  
 www.pfeifer.es

**SINGAPORE**

J&P Building Systems Pte Ltd.  
 No. 48 Toh Guan Road East  
 #08-104 Enterprise Hub  
 SINGAPORE 608586  
 Phone: +65 (0) 6569 6131  
 Fax: +65 (0) 6569 5286  
 E-mail: info@jnp.com.sg  
 www.jnp.com.sg

**ROMANIA**

S.C. JORDAHL & PFEIFER TEHNICĂ DE  
 ANCORARE S.R.L  
 Str. Malului Nr. 7, et.1  
 550197 Sibiu jud. Sibiu, Romania  
 Phone: +40 (0) 269 246098  
 Fax: +40 (0) 269 246099  
 E-mail: info@jordahl-pfeifer.ro  
 www.jordahl-pfeifer.ro

**POLAND**

JORDAHL & PFEIFER TECHNIKA  
 BUDOWLANA SP. Z O. O.  
 ul. Wroclawska 68  
 55-330 Krępiec k/Wrocławia, Poland  
 Phone: +48 (0) 71 3968264  
 Fax: +48 (0) 71 3968105  
 E-mail: biuro@jordahl-pfeifer.pl  
 www.j-p.pl

**Disclaimer**

1. This work and all its parts are protected by copyright law. Use of this work is not permitted without the agreement of H-BAU Technik GmbH. 2. All texts and diagrams in this printed product have been developed and compiled with the utmost care and serve to provide preliminary information. Nevertheless, errors cannot be completely excluded. The publisher shall assume no liability, irrespective of the legal grounds for this. Previous documents shall become invalid with the issue of this document.



# Forward Constructing.

**H-BAU TECHNIK GMBH**

Am Güterbahnhof 20

79771 Klettgau, Germany

Phone: +49 (0) 7742 9215-0

Fax: +49 (0) 7742 9215-129

E-mail: [info@h-bau.de](mailto:info@h-bau.de)